

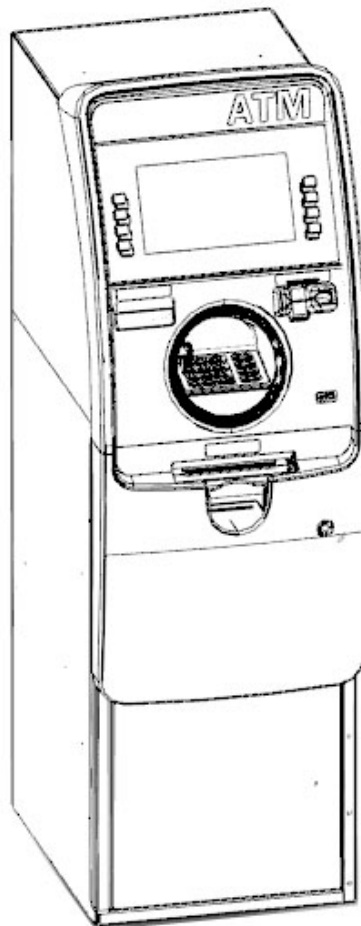

Operator Manual

NH2600 System

V01.00.00 (2013. 6.25)



Contents

Chapter1. Preface	1-1
Purpose	1-1
Audience	1-1
Support Information	1-1
What is in This Manual	1-1
Conventions	1-2
Safety Precautions (English)	1-4
Précautions pour la sécurité (French)	1-6
Related Document	1-8
Chapter2. Introduction	2-1
About the NH2600	2-1
The Exterior Overview	2-2
The Interior Overview	2-3
Basic Features	2-4
Devices of NH2600	2-6
Customer Display & Keypad	2-6
Cash Dispenser Unit	2-7
Receipt Printer	2-8
Card Reader	2-9
Main Control Board	2-10
Lighting LED	2-11
Chapter3. For the beginning operator	3-1
Opening the Exterior Door	3-1
Upper Front Body Opening	3-1
Security Enclosure Opening	3-2
Switching Power On/Off	3-3
Switching Power On	3-3
Switching Power Off	3-4
Lighting LED	3-5
Opening/Closing the Security Enclosure (Security Door)	3-7
Chapter4. Cash Dispenser	4-1
Bill Conditions	4-1
Acceptable condition	4-1
Unacceptable condition	4-2
How to Replenish the Cash Cassette	4-6
How to Empty the Reject Bin	4-8
How to Clear Jam	4-9
Optional Cash Dispenser	4-10
Chapter5. Receipt Printer	5-1
Receipt Paper	5-1
How to load the receipt paper	5-3
How to Clear a Receipt Jam	5-5
Index	Index-1
Memo	Memo-1

Chapter1. Preface

Purpose

- ▶ This manual is produced to describe how the customers operate Nautilus Hyosung's NH2600.

This manual details how the customers replenish the notes and paper and how they remove the jam at the NH2600.

Audience

- ▶ Customers and staffs of Nautilus Hyosung who use and operate the NH2600 in each branches of bank.

Support Information

- ▶ If any question or error occurs while operating NH2600 in compliance with this manual, please contact maintenance staffs of Nautilus Hyosung.
For the contact of maintenance staffs of Nautilus Hyosung, see the E-mail addresses and telephone numbers provided separately.

What is in This Manual

- ▶ This manual is designed to provide the operation guide for the NH2600 and the detailed description of the following:
 - Replenishing the notes and the receipt paper
 - Emptying the notes
 - Removing the jam like the notes and the receipt paper
- ▶ All measurements in this manual are in metric and () is inch scale.
- ▶ All information described in this manual is a licensed product of Nautilus Hyosung Inc.

Some of the information in this manual may differ according to the network processor to be connected and may be subsequently updated by the bank's needs or the improvement by Nautilus Hyosung Inc.

It is the policy of Nautilus Hyosung Inc to improve products as new technology, components, software, and firmware become available. Therefore Nautilus Hyosung Inc. reserves the right to change specifications without notice.

Conventions

► Terminologies

In this document the terminology listed below is used as follows:

- Customer and consumer refer to any person who transacts business through the ATM.
- Device and unit refer to the standard and optional ATM equipment, such as monitor, card reader, printer and dispenser.
- Fascia refers to the entire front portion of the unit, including the portion where the customer transacts business.
- Module refers to a plug-in device that can be serviced or replaced.
- Note(s) and bill(s) refer to the individual documents loaded into and dispensed from the dispenser.
- Servicing and maintenance refer to the supervisor, operator and technician's tasks performed to keep the ATM operational.
- Screen refers to the text appearing on the customer display.

► In this document the abbreviations listed below is used as follows:

#	Abbreviations	Description
1	AD board	Analog to Digital conversion Board
2	ADA	The American Disabilities Act
3	AP	Application Program
4	Assy	Assembly
5	BATT S/W	Battery Switch
6	CAM	Camera Unit
7	CDU	Cash Dispenser Unit
8	CE	Control Electronics
9	Earphone Jack	Voice Converter for Visually Disabled Persons (ADA)
10	EMV	Europay, Mastercard, Visa
11	EP	Elementary Program
12	EPP	Encryption PIN Pad
13	H/W	Hardware
14	I/F	Interface
15	ISO	International Standard Organization
16	JPR	Journal Printer
17	LCD	Liquid Crystal Display
18	MCU	Magnetic Card Unit
19	OPL	Operation Panel for Customers to Operate
20	OSD board	On Screen Display Board
21	P/S	Power Supply
22	PIN	Personal Identification Number
23	PNC	Panel Control Board

#	Abbreviations	Description
24	PTR	Printer (mainly Receipt Printer)
25	S/W	Switch
26	SIU	Sensor and Indications Unit
27	SP	Service Provider
28	SPR	Slip Printer (Receipt Printer)
29	TTU	Text Terminal Unit (OPL or SPL)
30	VFD	Vacuum Fluorescent Display

Safety Precautions (English)

► Common Safety Precaution



Precautions outlined this manual provide information on safe and proper handling of the product. Non-compliance of the precautions may result in injury or damage to the product. This precaution symbol with sample term tells you safety warnings during equipment handlings.



► Please read the following instructions before operating equipment.

- Operate equipment in the order outlined in this manual.
- Follow precautions indicated in this manual, as well as the equipment itself.
Failure to properly address these precautions may lead to injury or damage to the product.
- Avoid operations not addressed in this manual.
- If you cannot remedy system problems using the methods outlined in this manual, please refer to contact information listed in the manual.
- Any change or modifications in construction of this device which are not expressly approved by the party responsible for compliance could void the user's authority to operate the equipment.

<Note!>

This equipment has been tested and found to comply with the limits for a Class A digital device, pursuant to part 15 of the FCC Rules. These limits are designed to provide reasonable protection against harmful interference when the equipment is operated in a commercial environment. This equipment generates, uses, and can radiate radio frequency energy and, if not installed and used in accordance with the instruction manual, may cause harmful interference to radio communications. Operation of this equipment in a residential area is likely to cause harmful interference in which case the user will be required to correct the interference at his own expense.

► Description of Precaution Symbols

Symbol	Description
	<p>Electrical Shock Warning</p> <ul style="list-style-type: none"> ▪ Do not remove cover. Only a maintenance engineer is allowed to open the cover. ▪ Do not touch. You may receive electric shock. ▪ Make sure to turn off the power when servicing the equipment.
	<p>High Temperature Warning</p> <ul style="list-style-type: none"> ▪ Do not touch the equipment when it is running. ▪ The equipment can get extremely hot and may cause a burn. ▪ Make sure to close the cover before running the equipment.

	<p>Use Precaution when Moving</p> <ul style="list-style-type: none"> ▪ The equipment is heavy. Make sure at least 2 people lift or move the equipment. ▪ Do not attempt to move the equipment alone. You may be injured from dropping the heavy equipment.
	<p>Fire Hazard</p> <ul style="list-style-type: none"> ▪ Place the equipment in an area away from any combustible materials. ▪ The equipment may catch on fire from overheating or short circuit of the power supply unit.
	<p>Disassembly Warnings</p> <ul style="list-style-type: none"> ▪ Do not disassemble or modify the equipment unless you are a certified engineer. ▪ Contact the service center for maintenance, adjustments and repairs. ▪ Improper disassembly may cause fire or electrical shock.
	<p>Collapse Precautions</p> <ul style="list-style-type: none"> ▪ Do not place the equipment where the floor cannot sustain the weight of the equipment, or on slanted or unstable surface. ▪ Equipment may fall and cause injury or damage.
	<p>Unplug the Equipment</p> <ul style="list-style-type: none"> ▪ Stop using the equipment immediately if it smokes, emits an unusual smell, makes abnormal sounds, or if liquids or other foreign materials enter the equipment. ▪ If the above-mentioned abnormalities occur, immediately turn off the power, unplug the equipment and contact the service center. ▪ If you ignore these symptoms, the equipment may catch on fire or cause electric shock.

<CAUTION>

1. TO REDUCE THE RISK OF FIRE, USE ONLY No. 26 AWG OR LARGER TELECOMMUNICATION LINE CORD
2. RISK OF EXPLOSION IF BATTERY IS REPLACED BY AN INCORRECT TYPE. DISPOSED OF USED BATTERIES ACCORDING TO THE INSTRUCTIONS
3. FOR PLUGGABLE EQUIPMENT, THE SOCKET-OUTLET SHALL BE INSTALLED NEAR THE EQUIPMENT AN SHALL BE EASILY ACCESSIBLE
4. THE EQUIPMENT IS TO BE SECURED TO THE BUILDING STRUCTURE BEFORE OPERATION

Précautions pour la sécurité (French)

► Précaution générale pour la sécurité



Précautions décrits de ce manuel fournissent des informations sur une manipulation sûre et appropriée du produit. Le non-respect des précautions peut causer des blessures ou endommager le produit.

Ce symbole de précaution avec le terme d'exemple vous indique des consignes de sécurité lors de la manipulation de l'équipement.

- Veuillez lire des instructions suivantes avant d'utiliser l'équipement
 - Fonctionner l'équipement dans l'ordre indiqué dans ce manuel.
 - Suivre les précautions indiquées dans ce manuel, ainsi que l'équipement lui-même. Le défaut de traiter correctement de ces précautions peut entraîner des blessures ou endommager le produit.
 - Évitez des opérations non traitées dans ce manuel.
 - Si vous ne pouvez pas résoudre des problèmes du système en utilisant des méthodes décrites dans ce manuel, veuillez se référer aux informations de contact figurant dans le manuel, s'il vous plaît.
 - Certain changement ou des modifications dans la construction de ce dispositif qui ne sont pas expressément approuvés par la partie responsable de la conformité pourraient annuler l'autorité de l'utilisateur de faire fonctionner l'équipement.





<REMAQUE!>

Cet équipement a été testé et fondé pour se conformer aux limites pour un équipement numérique de classe A, conformément à la partie 15 des règles FCC. Ces limites sont conçues pour fournir une protection raisonnable contre des interférences nuisibles lorsque l'équipement est utilisé dans un environnement commercial. Cet équipement génère, utilise et peut émettre des fréquences radios et, s'il n'est pas installé et utilisé conformément aux instructions de ce manuel, peut causer des interférences nuisibles aux communications radios.

Le fonctionnement de cet équipement dans une zone résidentielle est susceptible de provoquer des interférences nuisibles dans le cas, l'utilisateur devra corriger ces interférences à ses propres frais.

► Description des symboles de précaution

Symbole	Description
	<p>Choc électrique</p> <ul style="list-style-type: none"> • Ne pas retirer le couvercle. Seul le technicien d'entretien est autorisé à ouvrir le couvercle. • Ne pas toucher. Vous pouvez avoir un choc électrique. • Assurez-vous d'éteindre l'appareil lors de l'entretien de l'équipement.

	<p>À haute température</p> <ul style="list-style-type: none"> • Ne pas toucher l'équipement quand il est en marche. • L'équipement peut devenir extrêmement chaud et peut provoquer une brûlure. • Assurez-vous de fermer le couvercle avant de lancer l'équipement.
	<p>Soyez prudent lors du déplacement</p> <ul style="list-style-type: none"> • L'équipement est lourd. Assurez-vous d'au moins 2 personnes pour soulever ou déplacer l'équipement • N'essayez pas de déplacer l'équipement seul. Vous pouvez être blessés par la chute de l'équipement lourd.
	<p>Risque d'incendie</p> <ul style="list-style-type: none"> • Placer l'équipement dans une zone éloignée de tous les matériaux combustibles. • L'équipement peut s'enflammer de surchauffe ou de court-circuit de l'unité d'alimentation.
	<p>Démontage</p> <ul style="list-style-type: none"> • Ne pas démonter ou de modifier l'équipement, sauf si vous êtes ingénieur certifié. • Contacter le centre de service pour l'entretien, le réglage et la réparation. • Le mauvais démontage peut provoquer un incendie ou un choc électrique.
	<p>Tomber</p> <ul style="list-style-type: none"> • Ne pas placer l'équipement dont le sol ne peut pas supporter le poids de l'équipement, ou sur une surface inclinée ou instable. • L'équipement peut tomber et provoquer des blessures ou des dommages.
	<p>Débrancher l'équipement</p> <ul style="list-style-type: none"> • Cessez d'utiliser l'équipement immédiatement si il fume, émet une odeur inhabituelle, fait des bruits anormaux ou si des liquides ou d'autres matériaux étrangers dans l'équipement. • Si les anomalies mentionnées ci-dessus se produisent, éteignez immédiatement la puissance, débranchez l'appareil et contactez le centre de service. • Si vous ignorez ces symptômes, l'équipement peut prendre feu ou provoquer un choc électrique.

AVERTISSEMENT :

1. POUR RÉDUIRE LES RISQUES D'INCENDIE, UTILISEZ UNIQUEMENT AWG n ° 26 OU LA LIGNES DE TELECOMMUNICATION PLUS GROSSE
2. RISQUE D'EXPLOSION SI LA BATTERIE EST REMPLACÉE PAR UN TYPE INCORRECT. DISPOSER POUR UTILISATION DES BATTERIES SELON LES INSTRUCTIONS
3. POUR LES APPAREILS RACCORDES, LA PRISE DOIT ÊTRE INSTALLÉE PRES D'EQUIPEMENT POUR ÊTRE FACILEMENT ACCESSIBLE

-
4. L'EQUIPEMENT DOIT ETRE SECURISE A LA STRUCTURE DU BATIMENT AVANT D'UTILISER

Related Document

- ▶ The related documents are listed as follows. If needed, please contact staffs of our technical support team and maintenance team.

- Installation Manual
- Service Manual

For the contact of maintenance staffs of Nautilus Hyosung, see the E-mail addresses and telephone numbers provided separately.

Chapter2. Introduction

About the NH2600

- ▶ Newly designed ATM - The NH2600's totally unique design enhances your customers' ATM experience. Unlike any other retail ATM, the sleek look and halo-like LED lights will attract more users and drive additional transactions thus delivering more revenue to your bottom line.

- ▶ Convenience everyone can enjoy - The NH2600 provides unsurpassed convenience to all users with its intuitive user interface presented on a vivid 10.1" color LCD screen, multi color LED indicator for the pin pad and Braille for visually impaired users. The NH2600 combines the best of Nautilus Hyosung's innovative design and engineering capabilities to ensure the speed and convenience your customers will love.

- ▶ Maximum Reliability - Leveraging our extensive experience in the Retail ATM industry, Nautilus Hyosung continues its industry-leading reputation for reliability and ease of service. The NH2600 incorporates proven cash dispensing technology widely regarded as the best in the industry. Ease of maintenance and simplified service also ensure maximum availability and uptime with minimal operational intervention.

- ▶ Green Technology - With leadership also comes responsibility. The NH2600 is equipped with energy saving features long lasting ATM parts designed to minimize environmental impact. Users can also be presented the choice of no receipt or to display an encoded digital receipt on the screen to minimize paper use.

The Exterior Overview

- ▶ The following picture shows the front of NH2600 and key units.

The fascia provides the interface between the customer and NH2600.
The customer selects transactions and requests information at the fascia.

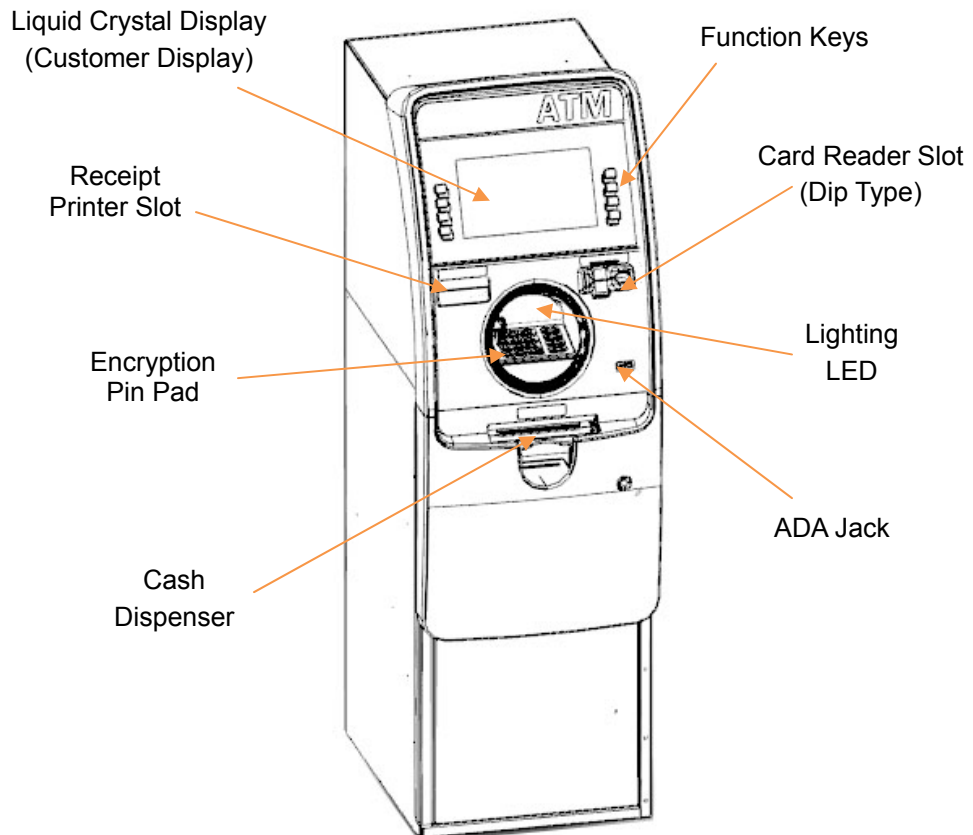

The Interior Overview

- ▶ The interior and key units of MX9200CM are as follows.

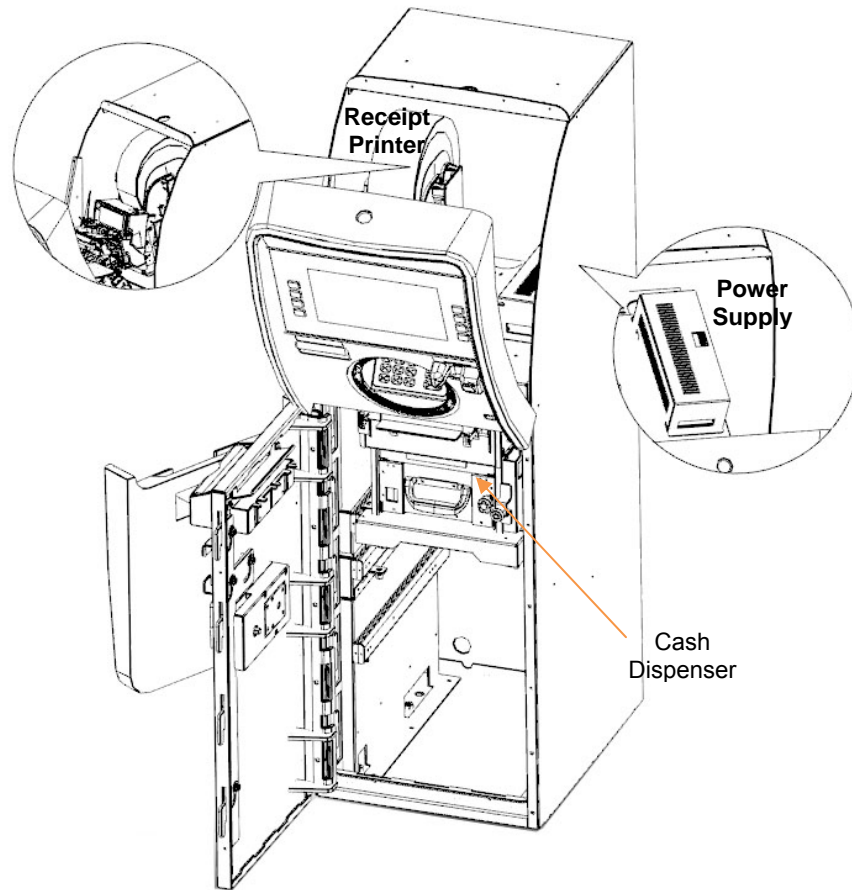

Basic Features

► Major features of NH2600 are highlighted in the following list:

Main Controller		
CPU		S5PC100 834MHz (ARMCortex-A8)
Memory	SDRAM	256MB
	Flash Memory	256MB
Operating System		WinCE 6.0
Serial Ports		8 Ports
Communication		MODEM & TCP/IP Selectable
Customer Display		
Display Type		10.1" TFT Color LCD 1024 X 600
Flicker		EPP Lighting LED Array, MCU Flicker
Customer Input Method		
PIN Pad		Plastic Key Cap EPP T-DES, PCI, RKT (Metal Key Cap)
Function Key		4X2 NDC Compatible
Cash Dispenser		
Number of cassettes		1 cassette 2cassette Option
Denomination		US Dollar
Maximum Dispense		40 Notes / Transaction
Cassette Capacity		1,000Notes / Capacity US Dollar Brand New 2K, 4K Option
Reject Type		Note by Note Reject (200 bills Max) Reject Bin
Card Reader		
Type		DIP Type EMV option
Receipt Printer		
Printing Type		Thermal Line Printing
Paper Setting Method		Semi-Automatic
Paper Specification	Type	Thermal Roll Paper
	Width	Max. 80mm [3.15inch]
	Outer Diameter	Max. 180Φ
Journal Printer		
Journal Printer		Electronic Journal
Safety		
Safety		UL Business-Hour Safety -
Locking device		Dial Lock Combo/Cencon Lock Option

Additional Function		
Audio guidance	Support	Speaker
ADA Audio guidance	Support	

<Note!>

Your NH2600 may not contain all the devices described in this section. Some devices are optional and some devices cannot be used in combination with other devices (mutually exclusive combinations).

Devices of NH2600

Customer Display & Keypad

- ▶ The customer display welcomes the customer and provides instructions for performing transactions at ATM.
During the transaction sequence, ATM prompts the customer to use the customer keypad to enter transaction information. The 16-key keypad uses a security module and encryption PIN pad technology to secure the information entered by the customer at the keypad.
The function keypads are made up of four keys mounted on each side of the customer display. The customer selects from the choices shown on the customer display and presses the corresponding function key.

Basic Specification of LCD

- Screen Size : 10.1 "
- TFT Color LCD

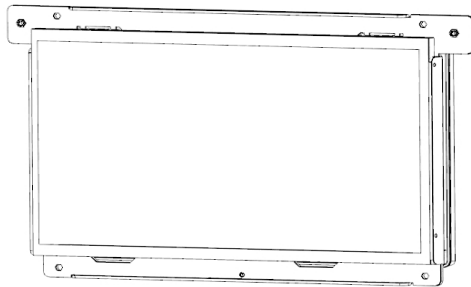

Basic Specification of Keypad

- 10 Alphanumeric , ◀ , ▶ , ENTER, CLEAR, CANCEL, BLANK Keypads
- 8 Function Keys
- Each Keypad has integral Braille symbol

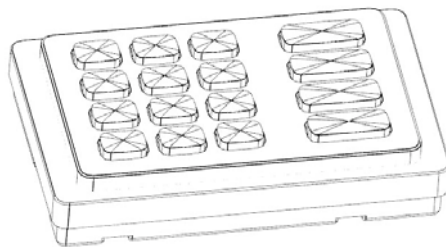

Cash Dispenser Unit

- ▶ The cash dispenser delivers media (cash) to the cardholder after the cardholder's request is processed by the network and the software. The media is drawn from the cassettes and transported to a slot in the fascia of ATM, where the cardholder can receive it. If the media is too mutilated or wrinkled to dispense, or if a multiple pick occurs, the dispenser sends the notes to the reject bin.

Basic Specification of Cash Dispenser Unit

- 1,000 new notes capacity cassette (US Dollar Brand New) supported
 - 1000/2000/4000 new notes (optional)
- 40 notes/ transaction
- Note by note reject (200 bills Max)

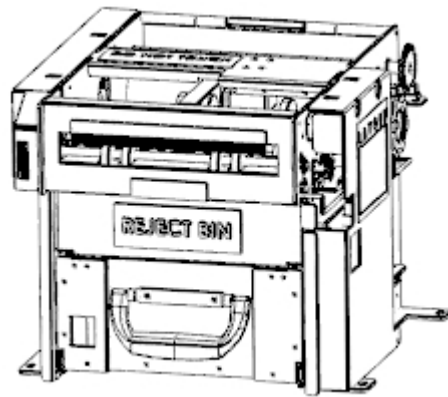

Receipt Printer

- ▶ The receipt printer provides a printed receipt of the customer's transaction. The transaction information can include the amount, ATM number, location and other desired information.

Basic Specification of Receipt Printer

- Thermal line printing type
- Semi-Automatic roll paper setting
- Printing Width is 80mm [3.15inch] Max

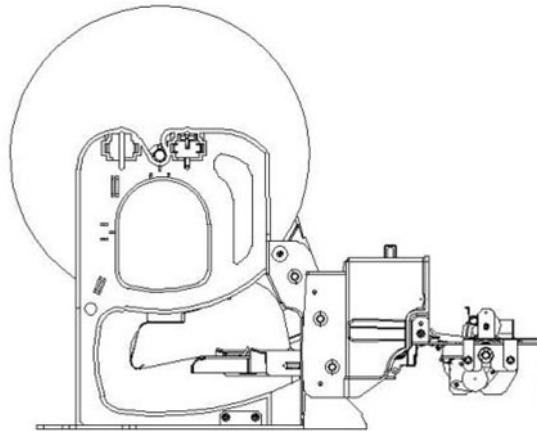

Card Reader

- ▶ The dip card reader is a manually operated device mounted directly to ATM fascia. The customer inserts an ATM card in the card entry slot and then removes the card to begin the transaction. The dip card reader can read magnetic stripe cards and memory chip cards. The dip card reader cannot retract, capture, or retain cards.

Basic Specification of Magnetic Card Reader

- Dip type Card Reader
(EMV option)

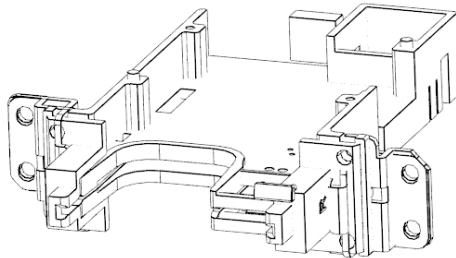

Main Control Board

- ▶ This motherboard is applied to NH2600 based on Window CE.

Basic Specification of Control Electronics

- S5PC100 834 MHz (ARM Cortex-A8) CPU
- SDRAM (256MB), Flash Memory (256 MB)
- Operating system : Windows CE 6.0
- Serial ports : 8 Ports
- Communication : Modem & TCP/IP Selectable

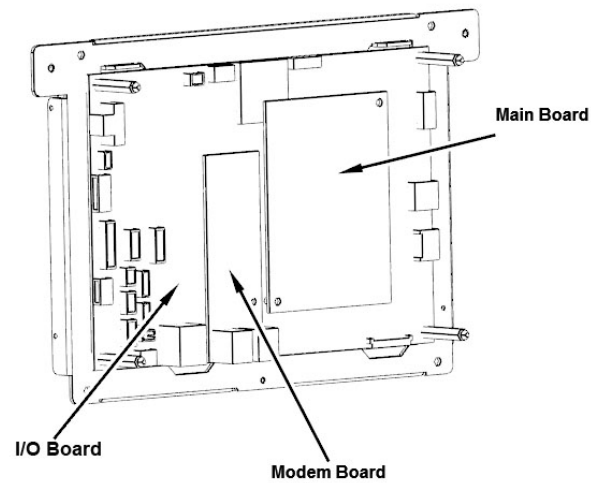

Lighting LED

- ▶ The colors of lighting LED are changed using RGB LED Light Source and is designed so that user can select the color. The boards are composed of Front Ring Light board and Back Light Control Board. The Back Light Control Board controls power and signal.

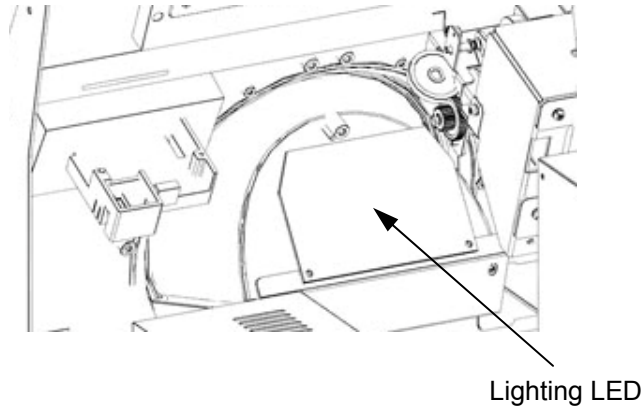

Chapter3. For the beginning operator

Opening the Exterior Door

- ▶ NH2600 has locks for the upper & lower bay door can be opened with key as well as locks for the Vault. Additionally, CDU Cassette has key lock.

Upper Front Body Opening

- ▶ Opening Front Body
 1. Insert the Front Panel key and turn it clockwise. Then pull the front panel outward.

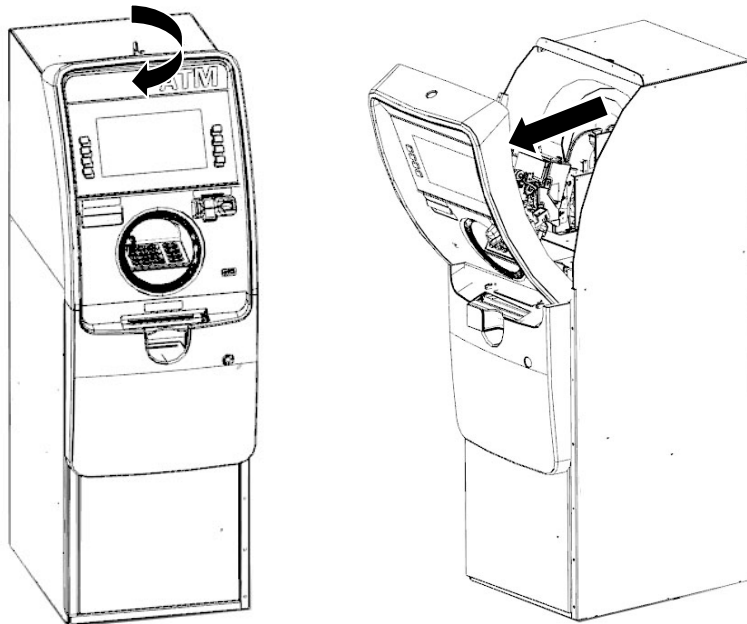

2. Use the reverse order of above description to close the Front panel

Security Enclosure Opening

- ▶ Open the Security Enclosure as follows
 1. Turn the security cover key clockwise to open the security cover. (①)
 2. Unlock the dial lock referring to “How to open the dial lock.”
 3. Turn the security door handle counterclockwise, and then pull the security door to open it.

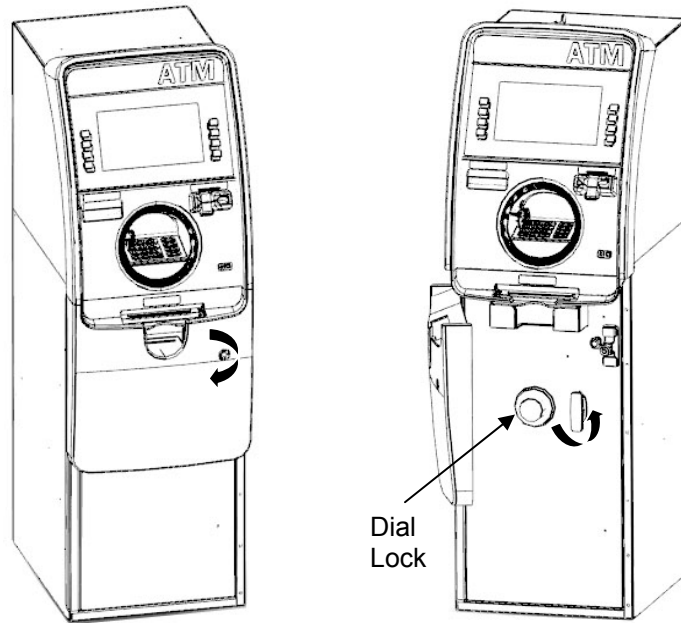

4. Use the reverse order of above description to close the security cover and door.

Switching Power On/Off

Switching Power On

- ▶ The power supply unit allows the user to turn on/off the system, enter power-failure mode, and perform other sequences.
 1. The system turning-on process is as follows
 2. Open the upper front door
 3. Press the power switch ("I").
 4. The system will be turn on automatically



Switching Power Off

- ▶ The system turning-off process is as follows
 1. Open the upper front door
 2. Press the power switch ("O")
 3. The system will be shut down automatically
 4. The operating system will shut down then power will turn off.



Lighting LED

► Composition

The boards are composed of Front Ring Light board and Back Light Control Board. The Back Light Control Board controls power and signal.

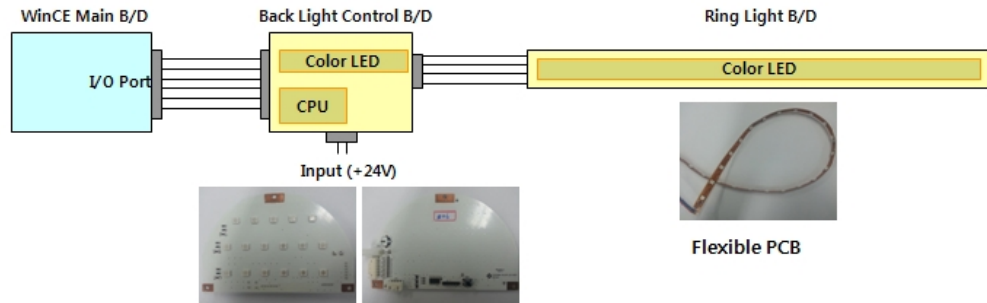

► Operation Method

This supports 4 types of operation mode and 7 colors (fixing 6, change 1) and is controlled by S/W.

1. Operation Mode

No	Mode	Operation
1	OFF	All LED Off
2	FADE	Color Change, R->G->B
3	SOLID	One designated color of 6 colors turns on.
4	FLICKER	One designated color of 6 colors blinks.

2. List of Color

Solid/Flicker						Fade
Cyan	Blue	Yellow / Green	White	Green	Pink	R->G->B

3. Adjusting the brightness of LED

To adjust volume brightly, turn the button on the back light control board clockwise using small driver. (To turn down the light, turn the button counterclockwise.)

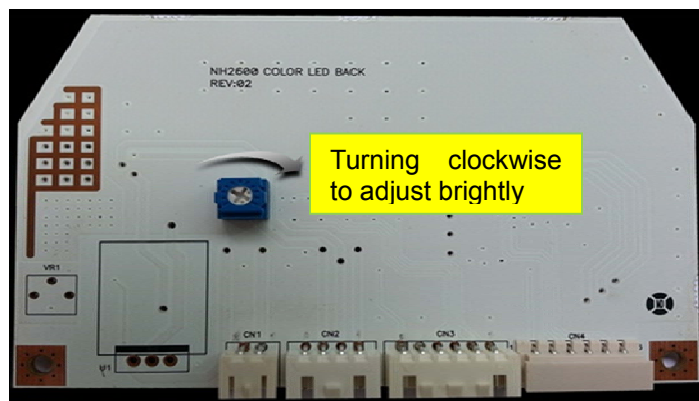
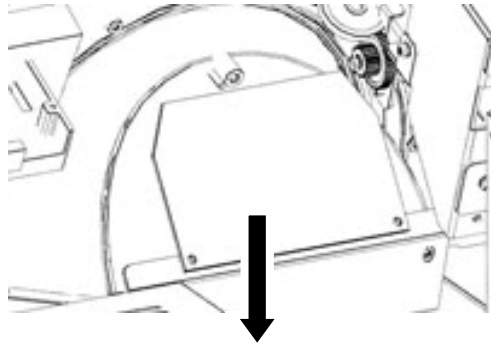

Opening/Closing the Security Enclosure (Security Door)

Dial Lock

How to open the dial lock

- ▶ Make sure that this lock would be set 50-25-50 as factory default setting.
 1. Turn to the counterclockwise for more than four times and set to "50."
 2. Turn to the clockwise and stop at "25" at the third times.

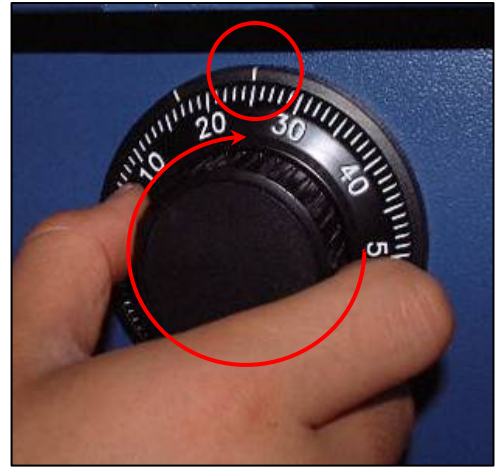
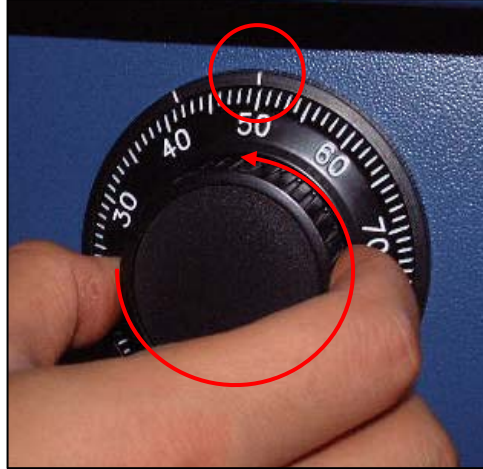

3. Turn to the counterclockwise and stop at "50" at the second times.
4. Turn to the clockwise until the dial does not move any more.

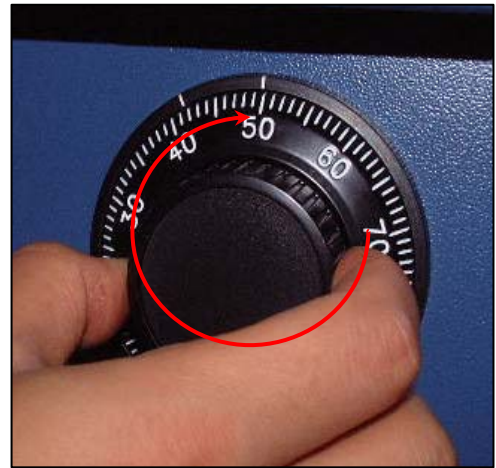

<Note!>

The center scale mark is used to open the safe unit

5. The safe door will open when turning the handle to counterclockwise.

How to set the new password

- ▶ For example, let's assume that you would like to set the following number (10-50-70)
 1. Open the safe door as described in the above.
 2. To close the mechanical lock, turn the handle to clockwise with the door opening
 3. Turn to the counterclockwise for more than four times and set to "50" at left scale indicator as shown in the Fig.1.
 4. Turn to the clockwise and stop at "25" at the third time as shown in the Fig.2.
 5. Turn to the counterclockwise and stop at "50" at the second times as shown in the Fig. 3.

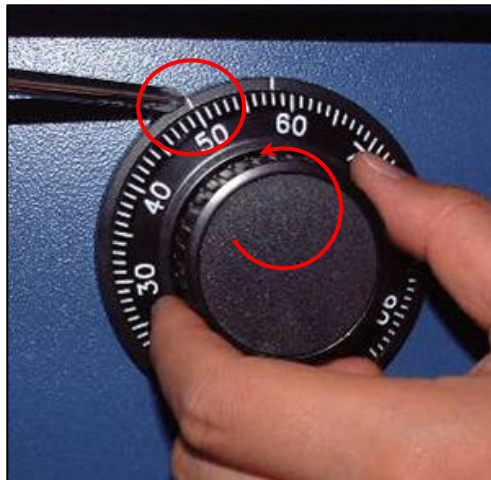

Fig.1

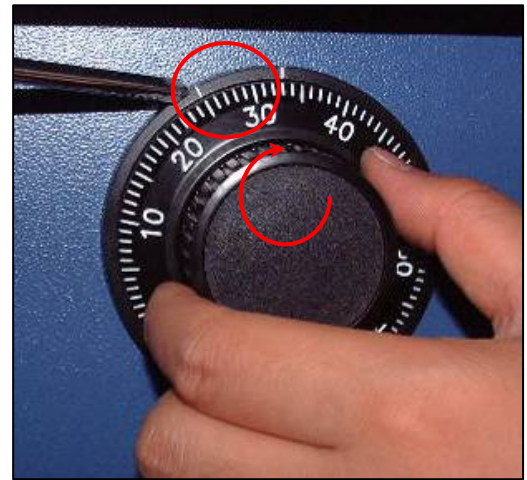

Fig.2



Fig.3

<Note!>

The left scale mark is used to change the password.

6. Push the change bar completely until it is held by the dial change home (Fig.4) inside the safe door and turn to the clockwise by 90 degrees (Fig.5).

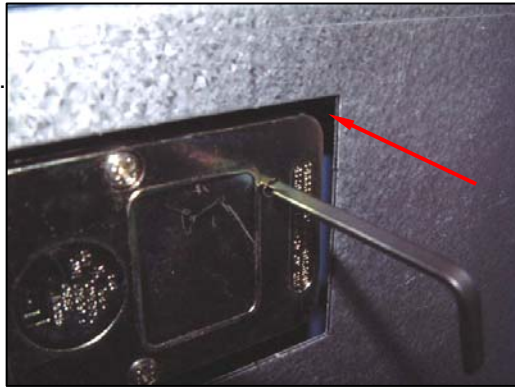

Fig.4

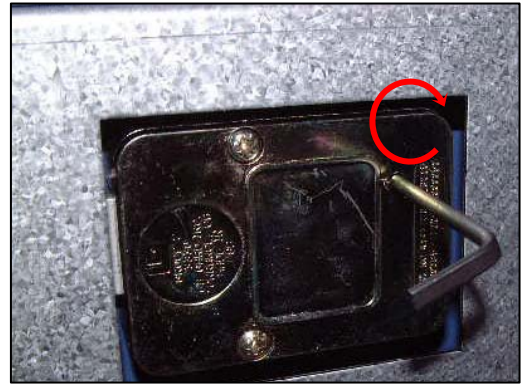

Fig.5

7. Turn to the counterclockwise more than four times and position at left scale indicator to "10" (target number to change).
8. Turn to the clockwise for three times and position the scale to "50" (target number to change).
9. Turn to the counterclockwise for two times and position the scale to "70" (target number to change).



Fig.6



Fig.7



Fig.8

<Note!>

Do not use number 0 – 20 as the last password number.

10. When password setting is completed, turn the change bar counterclockwise and remove it from the safe as shown in the Fig.9.



Fig.9

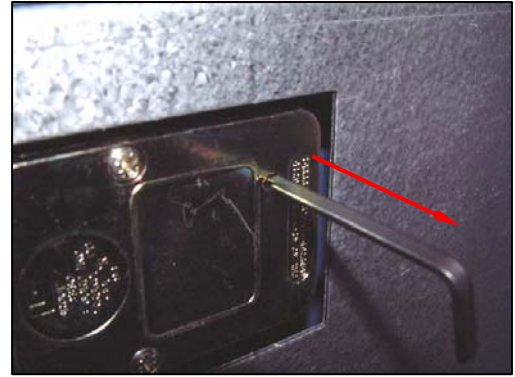

Fig.10

11. When password setting is completed, try to turn the dial more than a couple of times while the door is open to see if the door is opened or not. (Make sure to run the open/close test for at least two or three times.)
12. When all setting is completed, inform the password to the person in charge while paying attention to password disclosure or lost.

<Note!>

Special attention must be paid and lost dial number cannot be restored.

Optional Lock 1: Electronic Lock

- ▶ Opening Electronic Lock
 1. The default combination for Electronic Lock is 1-2-3-4-5-6. Enter this sequence on the electronic lock keypad. The lock will confirm a valid combination entry with a double signal. Lock will signal three (3) times for invalid combination entry.
 2. Turn the vault door handle counterclockwise. The vault door will open.

- ▶ Wrong Try Penalty
 1. Entry of four (4) consecutive invalid combinations starts a five (5) minute delay period.
 - LED lashed red at ten (10) second intervals.
 2. At the end of the delay period, two (2) more consecutive invalid combinations will restart the additional five (5) minute delay period.

<Note!>

Entry will not respond to keystrokes during delay period.

- ▶ How to change the electronic lock combination

Always perform this operation with the door open.

 1. Enter **0-0-0-0-0-0**, six (6) zeros, into the Electronic Lock keypad.
 2. Enter in the old combination once.
 3. Enter in the new combination twice. Combinations must be six digits in length.
 4. If a mistake is made wait thirty (30) seconds and repeat steps 1-3.
 5. Test lock operation several times before closing the door.

<CAUTION>

When selecting a combination do not use birthday or other predictable data that could give correlation between the user and combination.

<Note!>

The Electronic Lock will signal three (3) times if the new combination is invalid and the old combination has been retained.

- ▶ Battery Low Warning
 1. Repeated LED flashing and beeping during an opening indicates that the battery is low and needs immediate replacement.
 2. Uses one (1) 9-Volt alkaline battery only. (Example: Duracell™ or Eveready™ alkaline batteries.) The replacement of batteries at least once annually is recommended.

<Note!>

If battery is depleted and will not allow lock to open, follow instructions below. Lock contains a non-volatile memory, even with batteries removed the lock will retain all programming.

► Changing Your Battery

1. Slide the keypad housing up and carefully pull away from mounting surface to expose battery compartment.
2. Remove the old 9-Volt alkaline battery.
3. Remove the connector by unsnapping it from the two terminals on the top of the battery.
4. Replace with NEW 9-Volt alkaline battery.

<CAUTION>

Hold onto battery terminal connector to avoid pulling the wires out of housing

5. Carefully position the keypad over the mounting screws and slide the keypad Housing down. Ensure there are no wires or cables trapped between the input pad and the safe door. Pinched cables can result in a short circuit.

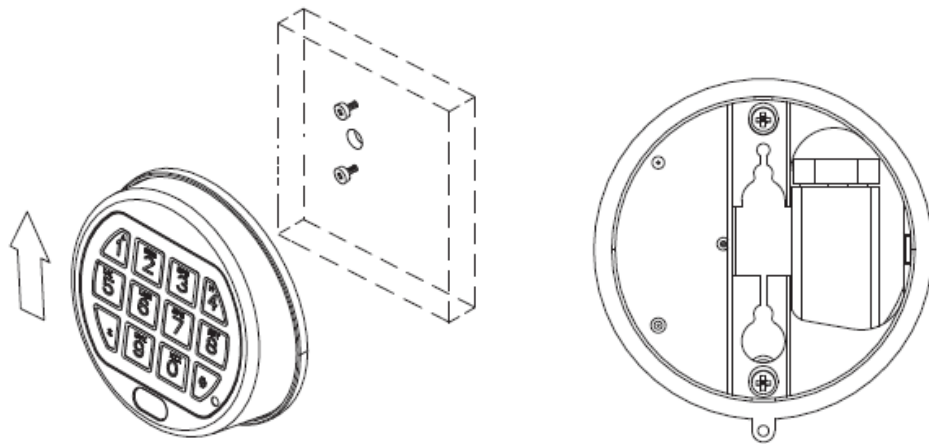

Optional Lock 2: Cencon Lock

► Security Door with Cencon

The Cencon lock is highly-secured, advanced-design lock. Even though the lock is electromechanical, they require no wiring or batteries for opening the lock because they are self-powered. Power is generated by turning the dial knob on the lock to the left (counter-clockwise). After several turns of the knob, enough power is generated to allow the microprocessor in the lock to function.

► Opening and closing the Security Door

Each Cencon Lock is shipped from the factory in Shelved Mode. The One Time Combination feature which requires a Smart Key is not available when the lock is shelved. Instead, the Shelved Mode combination is used to open the lock without any Smart Key. The default Factory Combination is set to 50-25-50. Practice opening the lock in shelved mode with the default factory combination until you are comfortable with its operation. The default combination may be changed, in which case the new combination would be used to open the lock while in Shelved Mode. The correct opening procedure for a shelved lock in:

1. Turn the dial to the left (CCW), using full wrist turns, until the letters "EC" (Enter Combination) appear on the LCD.



<Note!>

If you are operating a Cencon lock and **-dL** appears on the display during an operation, it indicates that you should **dial Left** (Counter Clockwise). The purpose is both to give the lock additional power and to ensure the lock bolt is fully extended.

CW = Clockwise; CCW = Counter Clockwise

2. Enter the factory combination of 50-25-50 by sequentially pressing those six buttons. The LCD will display the entered number.



- When the combination has been correctly entered, the LCD will read "OPr" meaning "Open right."



- Turn the dial right (CW) until it stops. The lock's bolt is now retracted and the lock is open.



- Turn the handle to the left (CCW) and open the security door.
- Turn the dial a minimum of one complete rotation to the left (CCW) to extent the bolt.



<Note!>

After opening and closing any lock, you should always check to ensure that the lock is physically relocked (i.e., bolt fully extended and locked in place) by turning the dial to the right. If the bolt does not retract, you can be assured the lock is secured.

Helpful Hint:

At any point while entering the combination during an opening sequence, if you notice that an incorrect number was pressed on the keypad, you may clear the entire operation and start again by pressing the star (*) key. This allows you to

return to the EC prompt without getting a wrong try error (lightning bolt).

Caution - Lock Out (LCO):

When the combination is incorrectly entered, a lightning bolt error will flash on the display (with no other numbers following it). To clear this error and start again, press and hold the star (*) key. Even in Shelved Mode, it is important to avoid getting 5 wrong combination attempts in a row without a successful opening in between because the lock will be put into Lock-Out condition, displaying, "LCO." Clearing the LCO condition in Shelved Mode requires waiting 5 minutes and then entering the correct combination.

► **Changing Shelved Mode Combination**

For Cencon Locks with a code level of 71¹, or greater, you may change the Shelved Mode combination. You may change the default Factory Combination of 50-25-50 to a new combination to be used while the lock is still in Shelved Mode. Once you have changed the combination for the first time, you may want to change the combination again to a different Shelved Mode combination. You can even change it back to the Factory combination of 50-25-50.

This is an option that is only available while the lock is in Shelved Mode and is intended only for temporary use after the ATM is deployed but before the lock is activated. It is not recommended to keep the Cencon lock in this Shelved Mode condition, due to lack of security and control.

Required Items:

Change Key, Current Shelved Mode Combination

<Note!>

You can only change the Shelved Mode combination while operating in Shelved Mode. Once a lock is "activated" in any mode, the Shelved Mode combination returns to the Factory Default of 50-25-50

To change the Shelved Mode Combination:

1. Power Lock → EC
Turn the Dial to the left (CCW) until "EC" (Enter Combination) is displayed.
2. EC → Enter Shelved Mode Combination → OPr
Enter the current Shelved Mode combination (either 50-25-50 or a changed Shelved

¹ It is sometimes necessary to determine the level of the Cencon Lock with which you are working. This can be done by entering a command via the keypad. The lock level will then be displayed on the LCD. Use the following procedure:

- 1) Power the lock by turning the dial to the left (counter clockwise) until EC is displayed.
- 2) Enter the # 1 keypad command. Then the lock displays a string of characters on the LCD, displaying two characters at a time. The best thing to do in analyzing the lock level is to write down the entire string and then pick out the portions of it that are significant to you, or if you are experiencing a problem with the lock, report the entire string to the Tech Support group.

Mode combination) by sequentially pressing those digits on the lock keypad. The numbers will be displayed on the LCD as they are entered. When the combination has been correctly entered, the LCD will read **OPr**, meaning "OPen right."

3. OPr → Retract Bolt

Turn the Dial to the right (CW) to retract the bolt

4. Open Door

5. Insert Change Key

Insert the change key into the change key socket on the back of the lock.

WARNING:

Do not close the door.

Leave the door open during this process until you are comfortable opening the lock with the new combination.

6. Extend Bolt

Turn the Dial to the left (CCW) to extend the bolt.

7. Power Lock → 

Turn the dial to the left (CCW) until  (the Change Key symbol along with Enter Combination) is displayed.

8.  → Press #8 → EcF

Press the “#” button followed by the “8” button. EcF (Enter current Factory combination) will be displayed

9. EcF → Enter Current Shelved Mode Combination → EnF

Enter the current shelved mode combination, “EnF” (Enter new Factory combination) will be displayed.

10. EnF → Enter New Combination → Cnf

Select and enter the new combination. “CnF” (confirm new Factory combination) will be displayed

11. Cnf → Enter New Combination → POC

Enter new combination again to confirm. POC (Pull Out Change key) will be displayed.

WARNING:

Record the new combination and store it in a secure place. If this combination is lost or forgotten, there is no alternate way to open the lock.

12. POC → Remove Change Key → EOP

Remove the change key. EOP (End Operation) is displayed.

13. EOP → Power Lock → EC

Turn the dial to the left (CCW) until EC (Enter Combination) is displayed.

14. EC → Enter New Shelved Mode Combination → OPr

Enter the new shelved mode combination by pressing those digits on the lock's keypad. The numbers will be displayed on the LCD as they are entered. When the combination has been correctly entered, the LCD will read OPr, meaning "**OP**en right."

15. OPr → Retract Bolt

Turn the Dial to the right (CW) to retract the bolt.

16. Close Door

17. Extend Bolt

Turn the Dial to the left (CCW) to extend the bolt.

Chapter4. Cash Dispenser

Bill Conditions

▶ **Acceptable condition**

1. Bill which is very clean and can readily be recognized as a true bill



2. Bill has sufficient life or sizing to be handled easily



3. Bill which can be manually held straightly when one end is held by a hand and the bill is slightly curved vertically

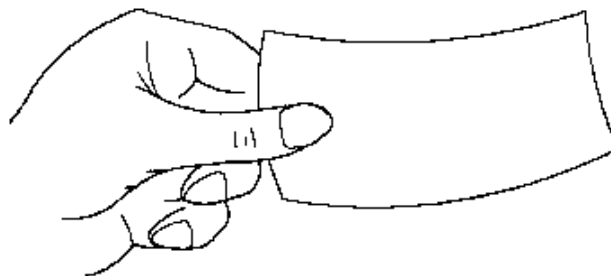

▶ **Unacceptable condition**

1. Bill having serious wrinkles, torn or broken section wherein paper fiber is broken and separation begins.

✓ Wrinkle

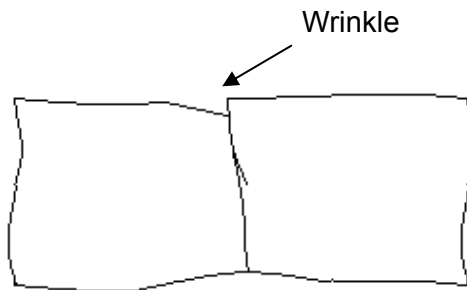

✓ Torn

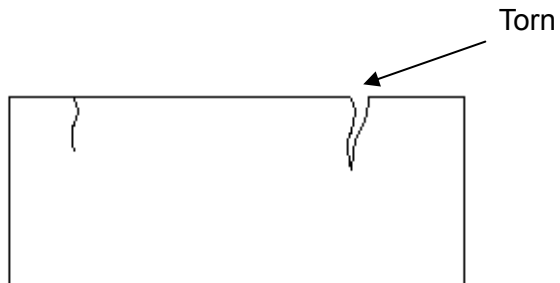

✓ Broken section

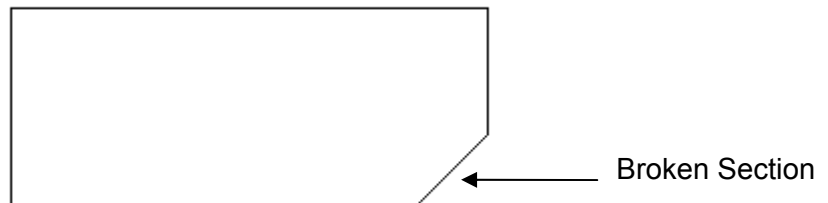

2. Bill having adequate life or sizing, but stained seriously

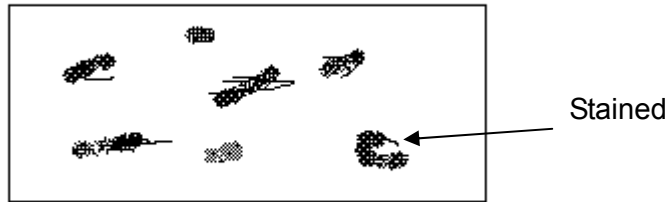

3. Bill with holes (Perforated bill)

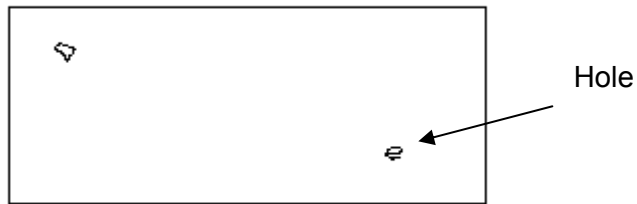

4. Bill ragged and cannot be held straightly when one end is supported by a hand

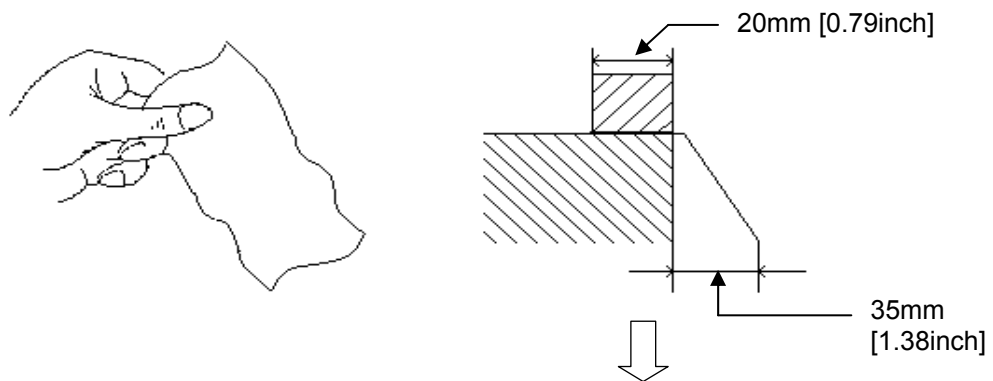

When the bill is held by 20mm [0.79inch] and the straightness of the bill is 35mm [1.38inch] or less, it cannot be used

5. Bill with cellophane tape, scotch tape, etc

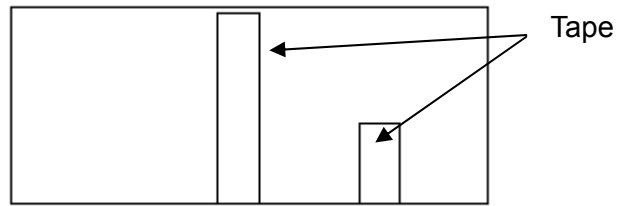

6. Bill with folds

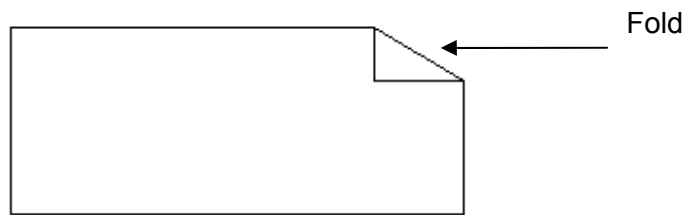

7. Gradually curved bill (bills tied by hand seal, etc)

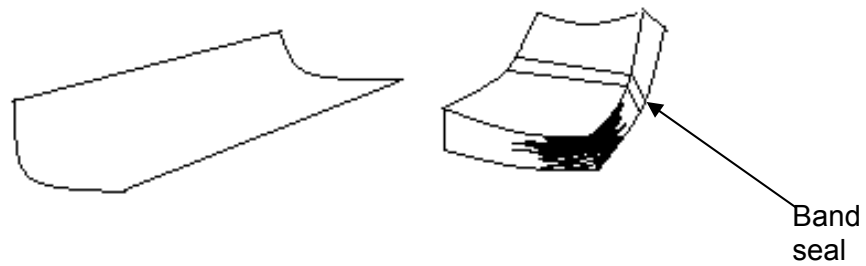

8. Bill with folded lines

✓ Case 1



✓ Case 2



✓ Case 3

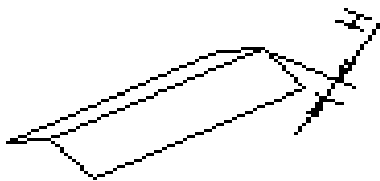

👁 Bill distortion should not exceed 10 mm [0.39inch]

► **Prior to replenishing the cash cassette with the notes,**

1. Fan the notes so that the notes are not sticking together.
2. Remove all notes with holes or notes that are torn.
3. Unfold the folded notes.
4. Place the notes correctly.

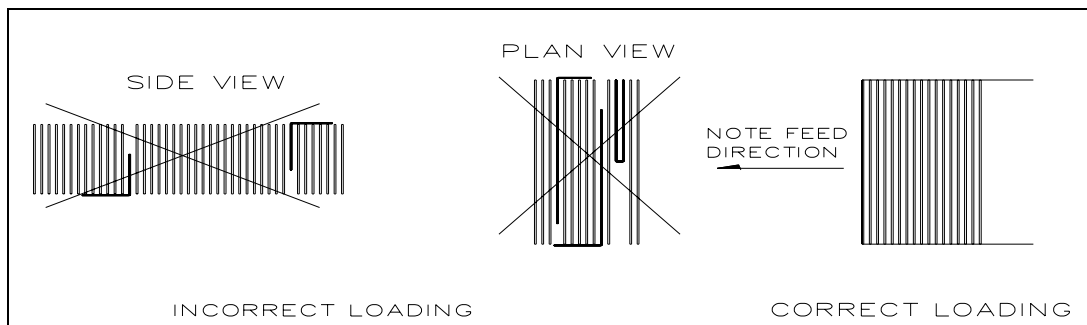

How to Replenish the Cash Cassette

1. Open the Security Cover and Door.

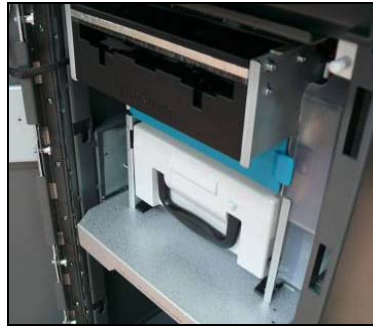

2. With one hand holding the cash cassette handle and the other hand supporting the cash cassette from the bottom, pull it out carefully.



3. Place the cash cassette on a flat level platform and turn the cassette key clockwise to unlock the cassette cover. Then lift the cassette cover.



4. Pull the cash plate back until it is locked against the cash plate latch. And then, replenish the cash cassette. (Refer to note below.)

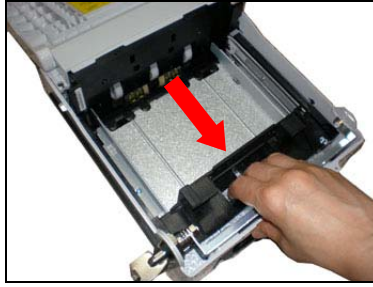

5. After replenishing the cash cassette, release the cash plate from the cash plate latch and allow it gradually to take up its position behind the notes.

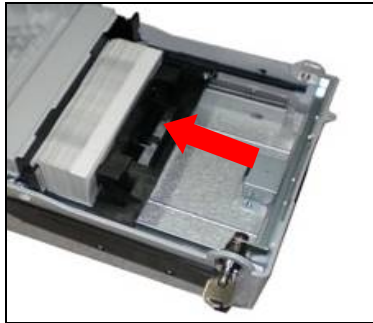

6. After closing the cassette cover, turn the key counterclockwise
7. With one hand holding the cash cassette handle and the other hand supporting the cash cassette from the bottom, place the cash cassette carefully on the set guide of the Cash Dispensing Unit and push it in until it is locked in place.



8. And then close the security door.

How to Empty the Reject Bin

1. Open the reject bin cover.

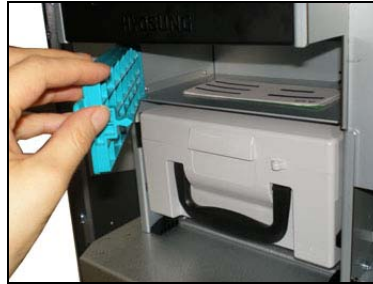

2. Remove the notes in the reject bin and close the reject bin cover.



[PRECAUTION!]

Don't recycle any bill in reject box into cassette.

Doing so will cause not only the same reject problem, but other unexpected problems such as note jam on cash dispenser

How to Clear Jam

1. Turn power off first.
Pull the rail on the bottom of the cash dispenser outward.

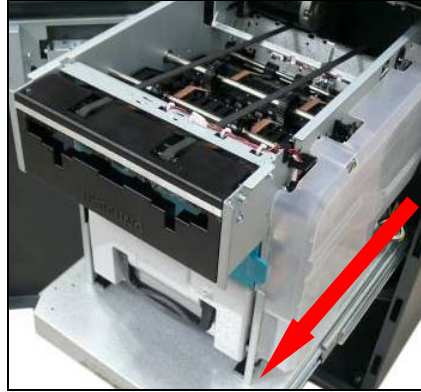

2. Move the belt in order to move jammed note into a well removed position
3. Take out the jammed note carefully.

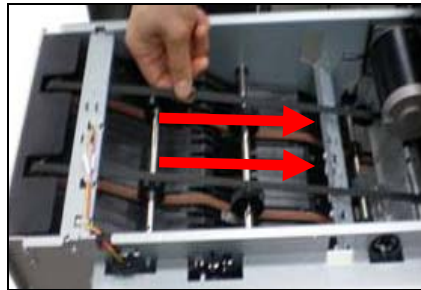

[WARNING!]

If the belt is detached from the Roller, the lifespan of the belt can be dramatically reduced which can result in breakage. Therefore, it is extremely important to check if the belt is positioned correctly after removing the jammed bills.

Optional Cash Dispenser

How to Replenish the Cash Cassette

1. With one hand holding the cassette handle and the other hand supporting the cash cassette from bottom, pull it up and out carefully.



2. Place the cash cassette on a flat level platform and turn the cassette key clockwise to unlock the cassette cover. Then lift the cassette cover.



3. Pull the cash plate back until it is locked against the cash plate latch.

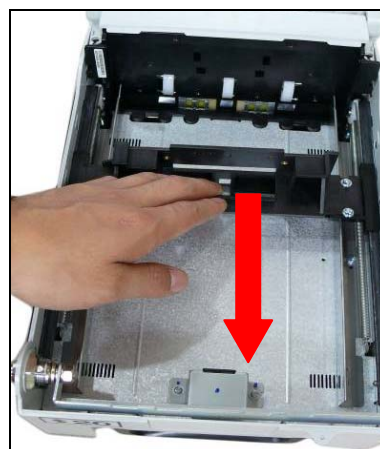

[PRECAUTION!]

Be careful not to hurt your hands when the black push-plate fails to get locked and suddenly recovers its positions

4. Replenish the cassette (Take note as below)

**[PRECAUTION!]**

Don't replenish more cash than recommended capacity. It means that it should be replenished less than 2,000 bills per cassette for new bills. Make sure that Cash Low Bracket in cassette will not be extruded outside cassette after replenishing cash.

5. Unlock the cash plate by pulling it again and move it smoothly.

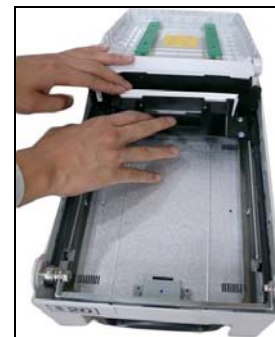

6. Close the cassette cover and turn the cassette key counterclockwise until it is locked.
Remove the key when it is locked.



7. With one hand holding the cassette handle and the other hand supporting the cassette from the bottom, place the cassette carefully on the set guide of the CDU and push it in until it is locked in place.



How to Empty the Reject Bin

1. Insert the reject box key, turn it clockwise.
2. Open the lid of reject box.



3. Take bills from the reject box and close the box with key.



[PRECAUTION!]

Don't recycle any bill in reject box into cassette. Doing so will cause not only the same reject problem, but other unexpected problems such as note jams on cash dispenser

How to Clear Jam

1. Turn power off first and pull the rail of CDU outward while pressing the green button on the CDU.

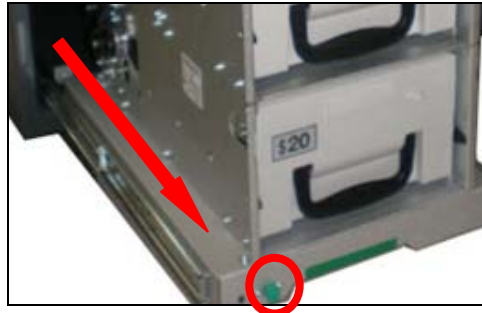

2. Turn the pulley located in left upper in order to move jammed note into a well removed position.

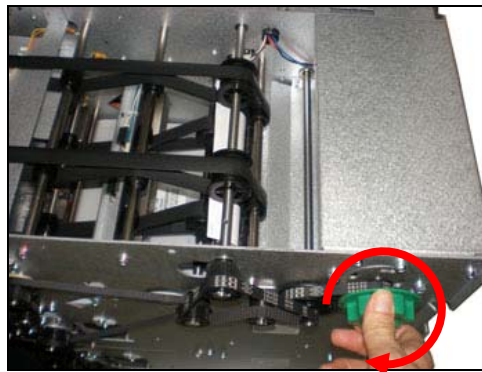

3. Take out the jammed note carefully.



4. Remove the cash cassettes to check whether there is any jammed note inside of CDU body. If so, remove the jammed note from it.



[WARNING!]

If the belt is detached from the Roller, the lifespan of the belt can be dramatically reduced which can result in breakage. Therefore, it is extremely important to check if the belt is positioned correctly after removing the jammed bills.

Chapter5. Receipt Printer

Receipt Paper

► Specifications

Item	Specifications	Remark
Type	Exterior Thermal Roll Paper	
Paper Setting Type	Semi-Auto Loading Type	
Paper Cutting Type	Full Cut	
Number of Transaction ^{Note1)}	4,100 ± 500 Transaction / Roll	Serial Communication Type 1 transaction = 101mm (3.98inch), based on Ø180 (55gsm)
	5100 ± 450 Transaction / Roll	USB Communication Type 1 transaction = 112mm (4.41inch), based on Ø210 (55gsm)

<Note!>

1) It can be different depending on the format.

► Roll Appearance

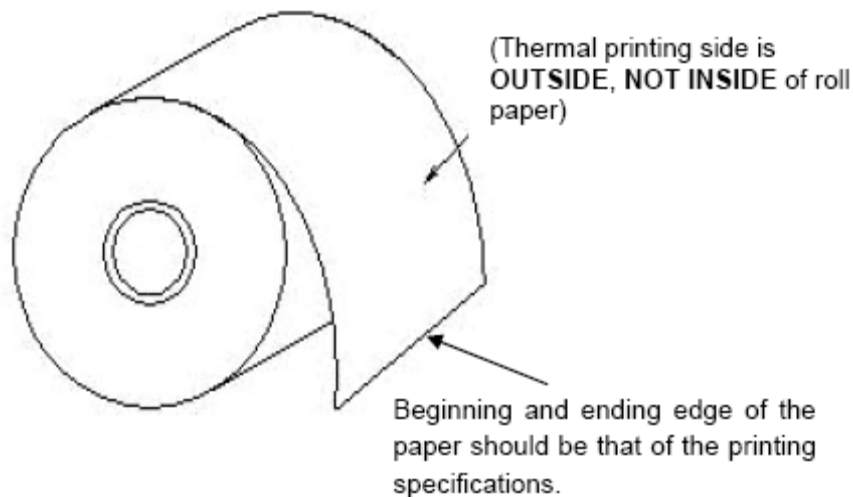

► Paper Handling Precautions

1. Store it away from high temperature and humidity:

If the paper is stored in a place where temperature is above 50°C [122°F] or humidity is above 90% RH, the coloring capability may deteriorate or the paper surface may inflate.

2. Refrain from exposing to direct sunlight:

The paper surface can be inflated if you expose it to direct sunlight or leave it under the fluorescent lamp for a long time.

3. Keep it away from the organic solvents:

Paper color may change if the paper comes in contact with organic solvents or glues containing organic solvent.

4. Keep it away from plastics:

If the paper comes in contact with materials containing plastics, its coloring capability may deteriorate or de-coloring of the paper may occur.

5. Store the paper roll separately to prevent damage to the paper.

6. Do not connect the papers with tape.

7. Make sure the paper end is not attached to the paper pipe.

8. Make sure the paper is rolled evenly.

9. Miscellaneous:

If the paper comes in contact with carbon copy paper or if the paper surface is scratched with a metallic object, de-coloring may occur.

How to load the receipt paper

- ▶ Prior to loading the receipt paper, the following must be kept in mind.

<Note!>

- 1) Load a paper roll into the unit with the shape of the roll kept intact. (Deformed roll may cause jamming.)

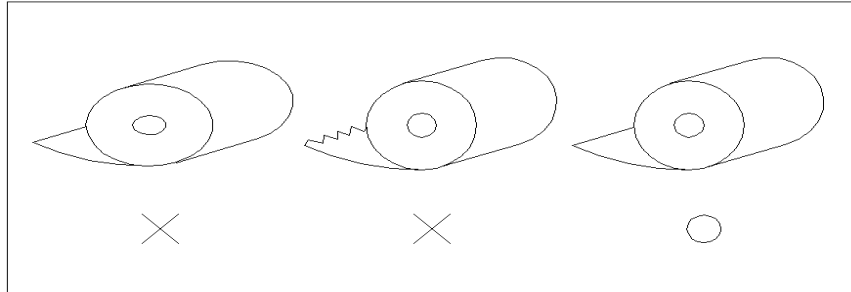

- 2) The leading edge of the roll shall neatly be cut prior to loading the roll. Correct shape of the paper roll

1. Open the Front Panel with key. (Please see “Opening the Exterior Door”)
2. Place the paper roll on the holder.



3. Set the paper so the metallic tension guide should be surrounded with paper as the figure below.



4. Insert the leading edge of paper between lower guide and upper guide of the receipt printer slowly until the paper is going to start feeding.

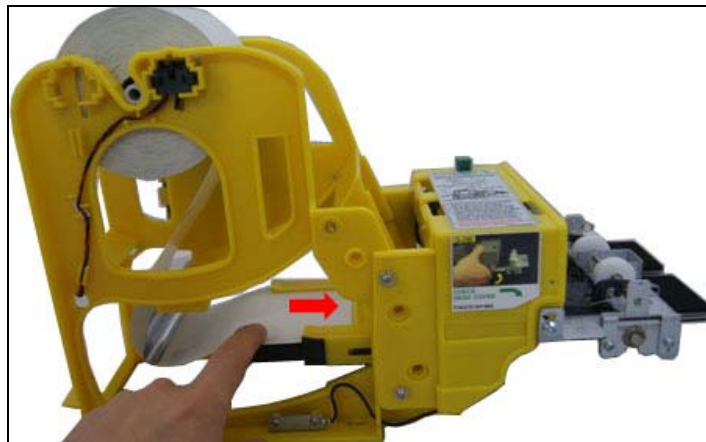

5. When finished loading paper, close the Front Panel.

How to Clear a Receipt Jam

- ▶ Removing paper jam
 1. Open the Front Panel with key.
 2. Check the receipt jam.

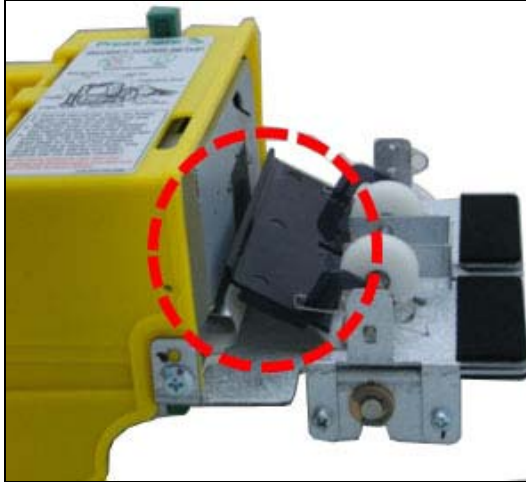

3. Press down the button to open the lever and lift up the transparent window guide.

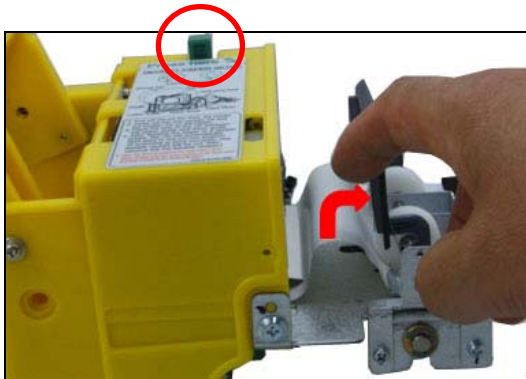

4. Remove the jammed paper carefully and close the lever (refer to the label attached on the side of the receipt printer).

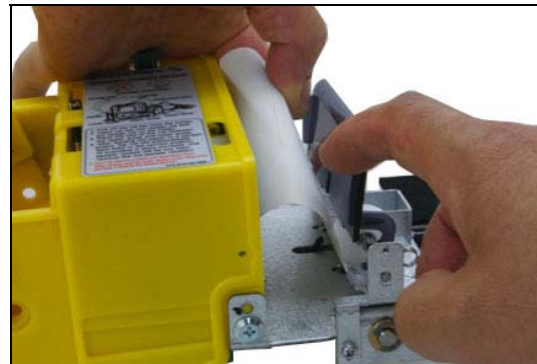
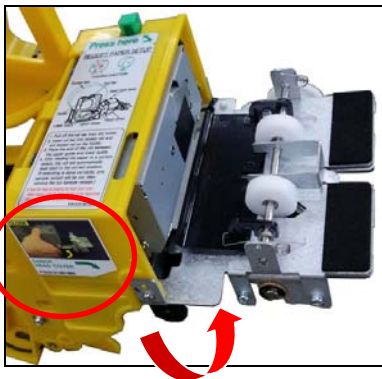

5. Set the paper. (Refer to "How to load the receipt Paper")

Index

Memo