

**MCWHORTER
ATM
SERVICES**



MODEL RL5000 (X2) SERIES AUTOMATED TELLER MACHINE USER MANUAL

VERSION 2.0
TDN 07100-00090B 05/2008

CORPORATE HEADQUARTERS

522 E. Railroad St.
Long Beach, MS 39560
Phone: (228) 868-1317
Fax: (228) 868-0437

COPYRIGHT NOTICE

© 2007-2008 Delaware Capital Formation, Inc. All Rights Reserved. Triton Systems of Delaware, Inc. is an operating company of Dover Electronics, Inc., a subsidiary of Dover Corporation (NYSE-DOV). DOVER, the DOVER logo and the Dover family of marks and TRITON, the TRITON logo and the Triton family of marks are registered trademarks of Delaware Capital Formation, Inc., a wholly owned subsidiary of Dover Corporation.

MODEL RL5000 (X2) USER MANUAL

NOTICES

Copyright © Delaware Capital Formation, Inc., 2007-2008.

ALL RIGHTS RESERVED

This publication is protected by copyright and all rights are reserved. No part of it may be reproduced or transmitted by any means or in any form, without prior consent in writing from Triton Systems of Delaware, Inc.

The information in this publication has been carefully checked and is believed to be accurate. However, Triton Systems of Delaware, Inc. assumes no responsibility for any inaccuracies, errors, or omissions that may be contained in this document. In no event will Triton Systems of Delaware, Inc. be liable for direct, indirect, special, incidental, or consequential damages resulting from any defect or omission in this manual, even if advised of the possibility of such damages.

In the interest of continued product development, Triton Systems of Delaware, Inc. reserves the right to make improvements in its documentation and the products it describes at any time, without notice or obligation.

TRADEMARK ACKNOWLEDGEMENTS

Microsoft Windows is a registered trademark of Microsoft Corporation in the United States and/or other countries. Triton Connect is a trademark of Triton Systems of Delaware, Inc. VISA® is a registered trademark of VISA of the United States and other countries.

MODEL RL5000 (X2) USER MANUAL

CONTENTS

SECTION 1 - INTRODUCTION	1
WHAT'S IN THIS MANUAL	2
FEATURE HIGHLIGHTS / CHANGES	3-4
STANDARD FEATURES	4-5
SECTION 2 - BASIC OPERATION	7
INTRODUCTION	8
CONTROL PANEL LAYOUT	8
FUNCTION KEYPADS	9
MAIN KEYPAD	9
ON-SCREEN KEYPAD OPERATION	10
MENU-BASED OPERATION	11
CUSTOMER TRANSACTIONS	12
VOICE-ENABLED TRANSACTIONS	14
SECTION 3 - CASSETTE CLOSE / CASH REPLENISHMENT	15
INTRODUCTION	16
DISPENSING MECHANISM	16
NOTE CONDITION	17
PREPARING NOTES	17
CASSETTE CLOSE PROCEDURES	18
REPLENISH CASSETTE(S)	
SDD	19
NMD-50	21
TDM-250	25
SECTION 4 - GENERAL MAINTENANCE	29
INTRODUCTION	30
REPLENISHING THE RECEIPT PAPER	30
CLEANING THE ENCLOSURE	33
CLEANING THE DISPLAY	33
CARD READER CLEANING	33

MODEL RL5000 (X2) USER MANUAL

CONTENTS

APPENDIX A - SOFTWARE LICENSE AGREEMENT A-1

APPENDIX B - WARRANTY STATEMENT B-1

APPENDIX C - COMBINATION LOCKS C-1

APPENDIX D - TDM “BACKGROUND PAPER” D-1

SUPPLEMENT A - T5 AND T7 EPP BATTERY REPLACEMENT PROCEDURES SA-1

SUPPLEMENT B - TDM STATUS CODES / CLICK COUNTS / TERMINAL ERROR CODES SB-1

HARDWARE STATUS CODES SB-2

CLICK COUNTS SB-3 THRU 10

TERMINAL ERROR CODES

SECTION 1
INTRODUCTION

MODEL RL5000 (X2) SERIES USER MANUAL

WHAT'S IN THIS MANUAL

The User manual describes the operating features of the Model RL5000 (X2) series ATM and shows how to perform the procedures that would typically be performed by the owner or operator personnel.

The manual is divided into the following sections:

SECTION 1, INTRODUCTION. Summarizes the basic features of the Model RL5000 series ATM.

SECTION 2, BASIC OPERATION. Describes the basic operation of the terminal.:

- Control Panel Layout.
- Keypads (Function, Main, On-Screen)
- Menu-Based Operation
- Customer Transaction Process
- Voice-Enabled Transactions

SECTION 3, CASSETTE CLOSE / CASH REPLENISHMENT. Describes the menu functions for cassette close procedures. Cash replenishment steps for each dispenser and standards are covered as well.

SECTION 4, GENERAL MAINTENANCE. Describes normal preventative and corrective maintenance procedures appropriate for user personnel.

- Replenishing Receipt Paper
- Cleaning the Enclosure/Card Reader

APPENDIX A - SOFTWARE LICENSE AGREEMENT / COMPLIANCE STATEMENTS

APPENDIX B - WARRANTY STATEMENT

APPENDIX C - COMBINATION LOCKS

APPENDIX D - TDM "BACKGROUND PAPER". A short background paper on the TDM mechanism.

SUPPLEMENT A - T5 AND T7 BATTERY REPLACEMENT PROCEDURES

IMPORTANT: Follow the instructions provided in SUPPLEMENT A of this manual for replacing the battery for the T5 PCI-EPP. Failure to follow the explicit instructions for the T5 will permanently damage the keypad!

SUPPLEMENT B - TDM HARDWARE STATUS CODES/ CLICK COUNTS/TERMINAL ERROR CODES. Error codes listing peculiar to hardware and communications protocol.

INTRODUCTION

FEATURE HIGHLIGHTS/CHANGES

Important features of the RL5000 (X2) series ATM are highlighted in the following list:

- Highly reliable, state-of-the-art operating system PC platform design. The RL5000 uses Microsoft® Windows® CE.5.0 operating system with Triton's X2™ technology. Supports Windows file formats for adding custom logos and advertisements. In addition, it features Triton's completely custom design X2 motherboard..
- Modular architecture eases troubleshooting and servicing.
- Easy to install (small footprint design makes placement easier) and configure terminal parameters by software.
- Front-access unit now accommodates single cassette (SDD) or multi-cassette (TDM -250, NMD-50) dispensing mechanisms.

Note: Previously, units could also be ordered with TDM-100, -150, and -200 dispenser options. These dispensers are no longer offered.

➤ Cabinet available in UL 291 Business Hours or UL291 Level 1 Safe models.

- Supports communication types TCP/IP (standard), Dial up (56K baud Triton USB modem - included), VSAT (satellite), Radio Pad, and wireless.
(Note: For wireless option, please contact your account representative for more information).
- VGA color Liquid Crystal Display (LCD) screen 10.4" (264 mm) supports attention-getting graphics.
- Multi-function, dip-style card reader supports magnetic stripe cards or "smart" cards that conform to the EMV standard - motorized card reader also available.
- PCI-compliant EPP to comply with international encryption standards and Triple DES compliant.

The VISA®-approved Encrypting PIN Pad (VEPP) has been replaced with a T5 PCI-compliant EPP.

The major differences between these two keypads:

- 1. Remote Key Transfer (RKT) - The T5 (plastic and metal-cased body) has the capability (upgradeable), the VEPP does not.**
- 2. Key Management Passwords - Requirements for entering/changing User passwords in the Key Management function are different for the T5 PCI-EPP. The process is detailed in SUPPLEMENT C in the X-Scale/X2 Configuration Manual included on the CD.**
- 3. User now has access to replace the battery (T5). CAUTION: Follow the instructions provided in SUPPLEMENT A of this manual for replacing the battery for the T5 PCI-EPP.**
- 4. The optional "METAL" T5 EPP (Metal casing) has a built-in heater - a feature more applicable for through-the-wall units (RT2000/FT5000).**

MODEL RL5000 (X2) SERIES USER MANUAL

FEATURE HIGHLIGHTS/CHANGES

- Graphics-capable 80 mm thermal printer (w/presenter) designed for quiet operation. The X2 platform uses a USB printer which has much faster communication than the X-Scale serial printer. The receipt printer prints receipts, coupons, and management reports.
- Electronic combination lock; Kaba Mas Cencon optional.
- Supports remote setup, configuration, and monitoring via Triton Connect™ ATM monitoring software.
- Dispenses U.S. and international currency types; NMD-50 capable of dispensing other paper-based media such as coupons or tickets.
- High-capacity electronic journal stores transaction details for later printout and analysis.
- Supports LED-backlit signage option (Mid or High topper attachment).
- Bayou Bronze control panel and fascia color.
- Satisfies Americans with Disabilities Act (ADA) specifications for height and access; audio transactions for the visually impaired. Complies with UK accessibility guidelines (DDA) and California access compliance, Title 24.

STANDARD FEATURES

- MANAGEMENT FUNCTIONS.** Enable extensive control and customization of the ATM's operating parameters. See "X-SCALE/X2 CONFIGURATION MANUAL" included on CD.
- PASSWORD PROTECTION.** Access to Management Functions and Key Management areas are protected with passwords.
- MAC ENCRYPTION SUPPORT.** Message Authentication Code (MAC) data encryption protocol. Provides increased protection for message traffic to and from the ATM. *Triple DES compliant.*
- PCI-COMPLIANT ENCRYPTING PIN PAD (EPP) ENTRY DEVICE SUPPORT.** Secure EPP device encrypts the customer PIN during a transaction. *Triple DES and PCI compliant.*
- MULTI-LANGUAGE SUPPORT.** Enables the customer to select a preferred language (such as French or Spanish) for customer screens and receipts.
- TRANSACTION AND ACCOUNT TYPE CONFIGURATION.** Enables selection of transactions (transfers or balance inquiries) or accounts (savings or credit card) that will be presented to the customer. Does not affect availability of checking account withdrawal.

INTRODUCTION

- ❑ **CASSETTE AND DAY CLOSE REPORTS.** Provide summary information about the number and type of transactions being performed by the ATM.
- ❑ **ELECTRONIC JOURNAL.** Stores the details of each transaction in solid-state memory. Journal data can be retrieved, printed, saved to an external storage device, or transferred to a remote Triton Connect™ computer.
- ❑ **AD SCREENS.** An Ad screen is a promotional or advertising graphic that is displayed on the LCD screen during idle periods. Ad screens are downloaded to the terminal by either using an external storage device (jumpdrive) or a remote Triton Connect™ computer. Text-only (non-graphic) ad screens can also be displayed.
- ❑ **RECEIPT PRINTER GRAPHICS.** This feature allows informational or promotional graphics to be printed on customer receipts. Graphics can be loaded from an external storage device or Triton Connect™.
- ❑ **MESSAGES.** Informational and promotional messages that are displayed to the customer on-screen or printed on receipts.
- ❑ **COUPONS.** Coupons can be printed by the receipt printer or dispensed (NMD-50). Prizes may be awarded to customers based on random and/or withdrawal amount-based transactions. Coupon text can be entered locally or downloaded along with coupon graphics using Triton Connect™ software.
- ❑ **STATUS MONITORING.** The ATM can periodically transfer status information to the host processor. In addition, Triton Connect™ remote monitoring software can be used to view the journal, monitor operation and alarm conditions, update operating parameters, and reset the terminal.
- ❑ **UL 291 BUSINESS HOURS AND LEVEL 1 (SAFE) SERVICE.** Business hours cabinet means currency should be removed from the dispenser and stored in a safe location when the business is closed to the public.
- ❑ **FRONT-ACCESS CABINET.** Allows access to the dispensing mechanism and currency cassette from the control-panel side of the unit.

THIS PAGE INTENTIONALLY LEFT BLANK

SECTION 2
BASIC OPERATION

MODEL RL5000 (X2) SERIES USER MANUAL

INTRODUCTION

This section describes the basic operation of the terminal. The following topics are covered:

1. **CONTROL PANEL LAYOUT.** Describes the layout of the terminal's control panel.
2. **KEYPAD OPERATION.** Describes the use of the alphanumeric keypads.
3. **MENU-BASED OPERATION.** Gives a general overview of the terminal display interface.
4. **CUSTOMER TRANSACTIONS.** Summarizes the actions involved in typical customer transactions. In addition, the voice-enabled transactions feature is described.

CONTROL PANEL LAYOUT

The user interface of the terminal consists of the LCD screen, receipt chute, card reader, speaker, headphone jack (visually impaired), and 24 keys on three keypads. The Function keys are arranged in two four-key groups, one group on either side of the LCD display. The main keypad consists of 10 alphanumeric keys, two arrow keys and four large control keys, all located in a 16-key group beneath the LCD screen.

The main keypad and control keys have an integral raised Braille symbol to conform to the requirements of the Americans with Disabilities Act (Figure 2-1).



Figure 2-1. Control panel layout.

BASIC OPERATION

FUNCTION KEYS

The eight (8) keys, arranged in two four-key groups, are called screen function keys. A screen function key is only active when a corresponding function or menu option is present next to that key. The Function keys are designated F1 through F8, as shown in Figure 2-2.

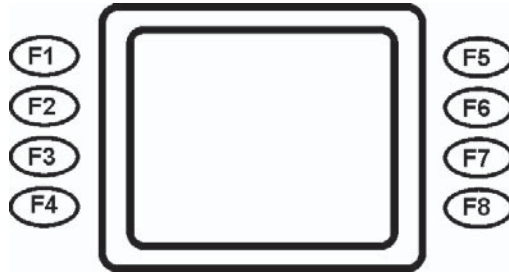

Figure 2-2. Function key layout.

MAIN KEYPAD

The entry of numeric characters via the main keypad is straightforward: simply press the desired key. However, in certain Management Function screens it may be necessary to enter alphabetic characters, a procedure that's available with the On-Screen keypad, explained on next page.

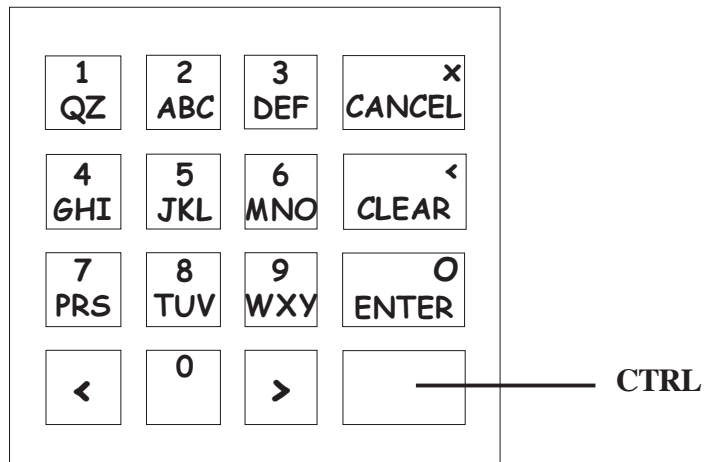

Figure 2-3.
Alphanumeric
keypad.

ON-SCREEN KEYPAD OPERATION

To enter text characters into the dialog boxes that are displayed by the Management Functions, press the **F8** key to display the screen keyboard. Use the keys described below to navigate and enter required data. (see Figure 2-4)

- The Arrow keys (< and >), the <8> key - (Up), and the <0> key - (Down) navigate the keyboard.
- Press the <ENTER> key to select the highlighted key entry.
- Press the <CTRL> key to switch between upper and lower case characters.
- Press the <CANCEL> key to Exit the keyboard.
- Press the <CLEAR> key for the Backspace operation.
- Press the <1> key to reposition the keyboard to another location on the display.
- Press the <2> key to position the cursor on a new line.

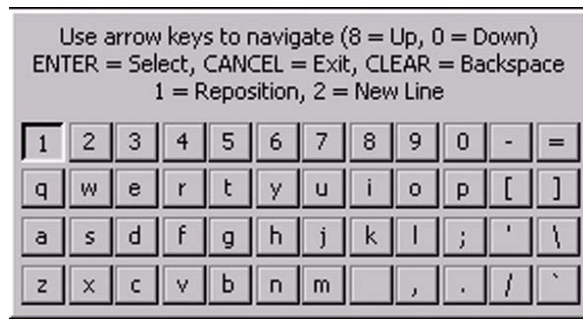

Figure 2-4. On-screen keyboard.

BASIC OPERATION

MENU-BASED OPERATION

The terminal operates as a menu driven system. Messages and menu options presented on the LCD display screen guide the user's actions. The desired menu option is selected by pressing one of the keys located to the left and right of the display. For the purpose of security many screens timeout after a preset time interval, usually 30 seconds. The timeout length may vary depending on the function being performed.

When a screen timeout occurs, a screen is presented which asks the user if more time is needed. If the user chooses NO, the Customer Welcome screen will be presented. If YES is chosen, the user is returned to the function that was active prior to the timeout. If the user does not make a selection within an additional 30-second countdown period the terminal will automatically go to the Customer Welcome screen.

Shortly after the unit is turned on, the top menu will be displayed. An example top menu is shown in Figure 2-5. From the top menu, you can either:

1. Activate the terminal to perform customer transactions by pressing the key next to **CUSTOMER TRANSACTIONS**.
2. Enter the terminal system management area by pressing the key next to **MANAGEMENT FUNCTIONS**.
Note: You will have to enter an appropriate password to view the Management Functions menu.

If you do not select a menu choice within 30 seconds the terminal will automatically default to the Customer Welcome screen (a benefit of this feature is that in the event of a power interruption the terminal will automatically begin accepting customer transactions shortly after power is restored).

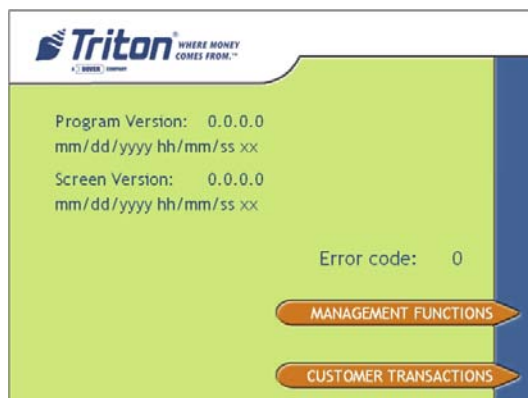

Figure 2-5. Top menu screen.

CUSTOMER TRANSACTIONS

A customer begins a transaction by selecting from the Customer screen options. They insert their ATM card into the card reader of the terminal. The card must be inserted so that the magnetic stripe can be scanned by the card reader's sensor. If the customer inserts the card incorrectly, a warning message will be displayed, accompanied by several beeps to get their attention.

If there is a problem reading a card, make sure the customer is inserting the card correctly. Most problems are the result of inserting the card incorrectly.

Once the card has been read in successfully, a surcharge message, if applicable, may be displayed (the surcharge message may be displayed at the end of the customer's transaction selection). The customer must then enter their Personal Identification Number (PIN) code. Once the PIN has been entered, the transaction type and account are selected, and the desired amount of the transaction, if needed. The transaction will be processed, typically in a matter of seconds.

Figure 2-6 shows how ATM transactions are handled. If the transaction was processed successfully, the customer is prompted to retrieve the requested cash (for withdrawal transactions) and/or the applicable transaction receipt, as needed. If the transaction was declined, a short receipt indicating the problem is printed.

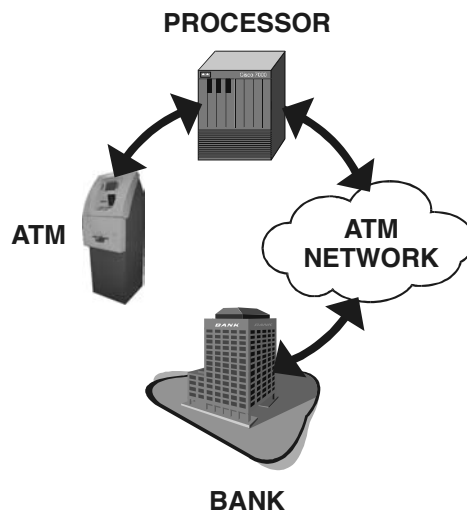

Figure 2-6. ATM transaction processing.

BASIC OPERATION

The ATM sends the customer transaction request to a processor. A processor is a financial intermediary, such as an Independent Sales Organization (ISO), bank, or other financial institution that provides transaction-processing services for ATMs. The ATM must be set up with a particular processor before customer transactions can take place.

The processor routes the transaction to the appropriate ATM network. An ATM network is a regionally or nationally organized clearing house for financial transactions, that deals directly with the appropriate financial institution, such as the customer's bank or credit card company, in order to complete the transaction. The processor will select the appropriate ATM network to use based on factors such as the type of ATM or credit card used, location of the customer's bank, or other considerations. The transaction may be transferred between several networks before ultimately reaching the customer's bank or credit card company.

The ATM network routes the transaction to the appropriate bank or other institution, confirms successful completion of the transaction, and sends a confirmation message back to the processor. If the request was for a cash withdrawal, an Electronic Funds Transfer (EFT) takes place to debit the funds (including any surcharge fee, if applicable) from the customer's bank account and credit the funds to the processor's bank account.

The processor forwards a confirmation message to the ATM (and an authorization to dispense currency, in the case of a cash withdrawal). The ATM dispenses the requested currency, if necessary, and provides the customer with a printed receipt as a record of the transaction.

The processor credits the merchant's account for the amount of any cash withdrawals (plus surcharge fees, if collected), typically by the end of the next business day).

VOICE-ENABLED TRANSACTION

The terminal provides voice feedback via an integrated output jack, enabling sight-impaired users to plug in a set of headphones and receive spoken instructions to assist them in using the ATM (Figure 2-7).

A raised symbol helps a user locate the headphone jack. The ATM will automatically detect when a headphone has been plugged into the jack, and will immediately switch into voice mode. Initially, a brief spoken tutorial will orientate the customer to the ATM control panel interface. Once the customer begins a transaction, spoken prompts will provide feedback and guide the customer through the successful accomplishment of the transaction.



*Figure 2-7.
Headphone jack location.*



SDD

SECTION 3

CASSETTE CLOSE CASH REPLENISHMENT



NMD-50



TDM-250

MODEL RL5000 (X2) USER MANUAL

INTRODUCTION

The purpose of this section of the manual is to describe the procedures for cassette closing and replenishment. Information concerning note handling and quality issues are explained where appropriate.

DISPENSING MECHANISM

*** PLEASE READ ***

Starting approximately Apr, 08', the Model RL5000 will only offer (production units) the following dispensing mechanisms - SDD, TDM-250, and NMD-50. Units previously also offered TDM-100, -150, and -200s.

Currency capacity depends upon the dispenser mechanism installed in the ATM, but is also affected by note quality and thickness. Typical capacities are provided in the following table:

RL5000 DISPENSING MECHANISMS			
DISPENSER	CASSETTE	RECOMMENDED MAXIMUM CAPACITY	REJECTED NOTE CAPACITY
TDM-250	Multiple	1300 Notes (per cassette)	100
SDD	Single	1800 Notes	50
NMD-50	Multiple	1850 Notes (per cassette)	200

The dispensing mechanism delivers the appropriate number of notes from the note cassette to fulfill the customer's withdrawal request. The purpose of the reject area or cassette is to accept and hold notes that have been transferred from the note cassette but not dispensed.

Some situations that could cause the mechanism to reject notes are:

- (1) Multiple notes stuck together (2) Note width too short or long.

Other conditions that could cause a reject are described in the next section, Note Condition.

****CAUTION****

DO NOT RECYCLE REJECTED NOTES INTO A CASSETTE!
Doing so could cause more rejects and/or currency jams.

CASSETTE CLOSE / CASH REPLENISHMENT

NOTE CONDITION

The number of rejects can be directly influenced by the technique used to load the cassettes and the quality of the currency. Notes loaded into the mechanism cassettes must be in “fit” condition if a high level of performance (low reject and failure rate) is expected from the unit. “Fit” notes are defined as those that do not possess any of the defects listed here:

USED NOTE DEFECTS

- ➔ Adhesive or “sticky” substances on the surface of the paper.
- ➔ Tears extending more than 1/2” from the edge of the currency.
- ➔ Tears, holes, or missing sections in the body of the currency.
- ➔ Tape on the surface of the currency used for repairing, patching or any other purpose.
- ➔ Staples, pins, or any other foreign body attached to the notes.
- ➔ Corner folds of a size greater than 1/2” on either axis.
- ➔ Two or more notes joined by any means.
- ➔ Excessively crumpled or crinkled.

PREPARING NOTES

Use the following procedures to prepare notes before inserting them into a note cassette.

PREPARING USED NOTES

- ➔ Remove the band around each bundle of notes.
- ➔ Remove foreign objects (e.g. pins, paper clips, crumbs, etc.).
- ➔ Remove torn or very worn notes.
- ➔ Straighten any folded notes.

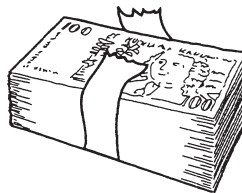

Figure 3-1. Removing band.

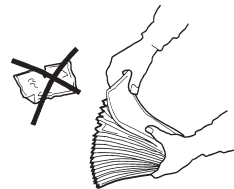

Figure 3-2. Removing torn/worn notes.

NEW OR UNCIRCULATED NOTES

Remove the band around each bundle of notes. Separate the notes from each other by:

- ➔ **Striking** the bundle hard against the edge of a table or similar object.
- ➔ **Flipping** through each bundle of notes in both directions at each end.
- ➔ Using a **note counter**.

CASSETTE CLOSE PROCEDURES

Follow Access instructions to enter **MANAGEMENT FUNCTIONS**. Select **TERMINAL CLOSE FUNCTIONS**. Select **CASSETTE CLOSE**.

- 1 Select cassette(s) to Close. A check mark (✓) identifies which cassette(s) are selected. Press <ENTER>.

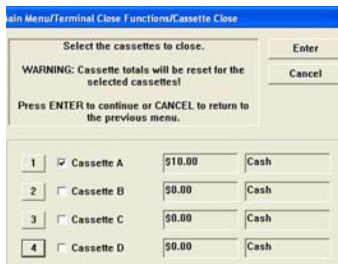

- 4 After cassette(s) have been reinserted in the dispenser, press <ENTER>.

Note: For an NMD-50/100 dispenser installed, wait for the cassettes to LOCK (this is done automatically). Press <Enter> if applicable.

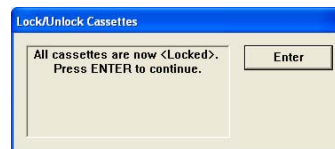

- 2 A Close report is displayed to be printed or saved. This operation will reset the number of bills in the cassette(s) to ZERO (0). Press <ENTER>.

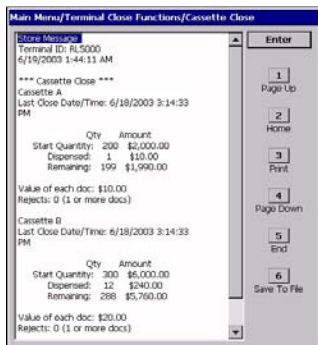

- 5 Place selected cassette(s) **IN SERVICE**. Press <ENTER>. *Note: The NMD-50/100 cassettes Must be Locked and In Service for normal operation.*

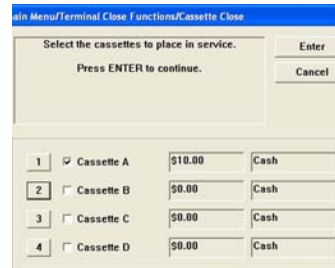

- 6 Enter Cassette Quantity (number of notes, NOT value) for the selected cassette(s). Press <ENTER> to accept entry. Repeat for each selected cassette.

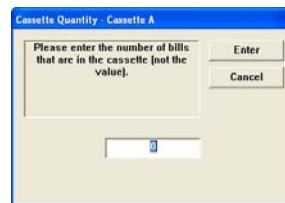

- 3 Remove and Replenish the selected cassette(s).

Procedures for cassette replenishment are on the following pages.

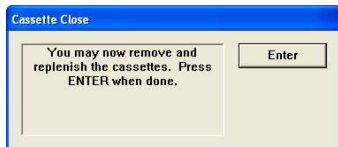

Note: If an NMD-50 dispenser is installed, wait for the cassettes to UNLOCK (this is done automatically).

- 7 A Trial Cassette Close report automatically is displayed to be printed or saved. Print and retain a copy for starting point reference. Press <ENTER> to return to Close functions.

CASSETTE CLOSE / CASH REPLENISHMENT

REPLENISH CASSETTE (SDD)

1. Unlock and open the security cabinet door.
2. To remove the cassette, grasp the handle on the front of the dispensing mechanism with one hand while holding the mechanism in place with the other hand and pull sharply. **Do not allow the cassette to swing freely when it is pulled out. It may strike a near by object or person causing damage to or injury to what it strikes!**
3. The cassette must be primed with the cassette key before it can be inserted onto the loading tray. Insert the key and turn clockwise to show the “GREEN” indicator in the window on the side of the cassette.



Removing cassette.

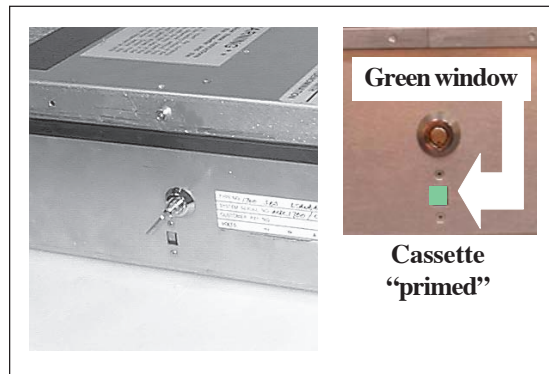

4. Place the cassette onto the loading tray provided with the back of the cassette facing the probes on the tray. The shutter is unlocked as the cassette is pushed into the probes.



Loading tray.

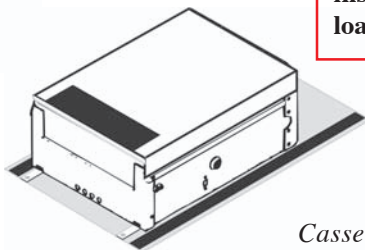

Cassette on loading tray.

*****WARNING*****

If **RED** is indicated in the window on the side of the currency cassette, **NEVER** attempt to insert the cassette into the dispenser or the loading tray!

MODEL RL5000 (X2) USER MANUAL

5. Lift the cassette lid to expose the reject tray. Remove any rejected notes. Lift the reject tray to gain access to the currency compartment.

Note: You may wish to record the number of notes removed from the reject tray for use when balancing the note tray against the cassette/day close records.

6. Pull the packer plate to the rear of the cassette (away from the shutter) until it locks to the white packer plate latch. It will be necessary to push down on the packer plate latch to lock the packer plate in place. The packer plate will be held in this position until the lid is closed or the latch is released by pushing it down. Be careful not to release the packer plate onto your fingers.

Cassette opened.

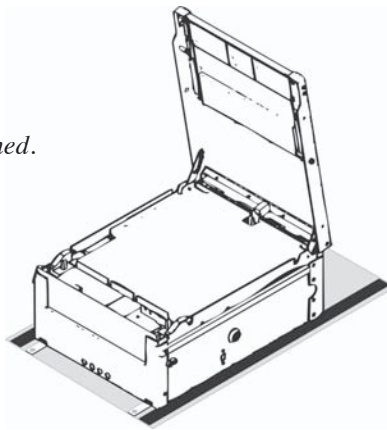

7. Count the number of bills that remain in the cassette, if any. Next, count the number of bills that are being added into the cassette.
8. Add the number of bills being placed into the cassette to the number that remained. The **“Total”** number of these bills will be entered in the **“ENTER CASSETTE QUANTITY”** option.
9. Place the currency into the cassette. Allow at least one inch of clearance between the packer plate when it is fully retracted and the currency. This will allow the packer plate to compress the currency.
10. Release the packer plate and lower the reject tray and the lid. The cassette can now be removed from the loading tray by sliding it away from the probes.
11. **Verify that the cassette is primed!** Be certain the **“GREEN”** indicator is showing in the window below the key! Install the cassette into the dispenser by placing the cassette guides on the dispensers’ rails and firmly pushing the cassette in until it locks in place.
12. Close and lock the security container.

CASSETTE CLOSE / CASH REPLENISHMENT

REPLENISH CASSETTE (NMD-50)

REMOVING NOTE CASSETTES

1. **UNLOCK** the cassettes, using the Cassette Close procedures. Open the vault door to gain access to the dispensing mechanism.
2. To remove the selected note cassette, grasp the cassette handle with one hand while holding mechanism in place with the other hand. Pull the cassette out slightly. Place one hand underneath to support the cassette as you slide it completely out of the unit. Continue to support the bottom of the cassette to keep it level as you place it on a table or other flat surface.



Removing note cassette.

OPENING NOTE CASSETTES

1. Open the cassette by simultaneously pressing the release button and lifting the lid. Flip the lid back fully, allowing it to rest on the table or other flat surface.
2. Move the pusher plate to the rear of the cassette (toward the handle). Ensure the pusher plate is fully back. It should stay in this position.



Press release button and lift top.

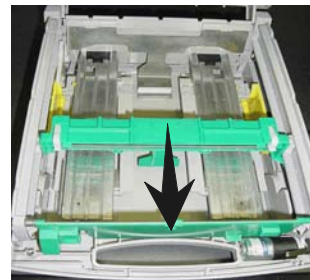

Pull packer plate back.

MODEL RL5000 (X2) USER MANUAL

LOADING NOTE CASSETTES

1. Count the number of bills that remain in the cassette, if any. Next, count the number of bills that are being added into the cassette.
2. Add the number of bills being placed into the cassette to the number that remained. The **“Total”** number of these bills will be entered in the **“ENTER CASSETTE QUANTITY”** option.
3. Move the pusher plate against the notes with just enough pressure to hold the notes.



Level the note pile.

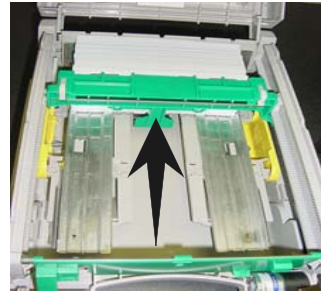

Slide packer plate against notes.

4. Move the white plastic levers (Pawls) on the pusher plate to their fully extended position. This will allow the pusher plate to retract and relieve pressure from the note stack when an unlock command is sent to the dispenser.

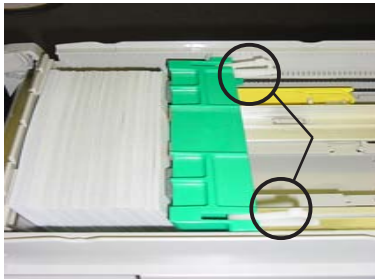

“Pawls” extended.

INSTALLING NOTE CASSETTES

Once the cassettes have been loaded with currency, reinstall them in the mechanism. Make sure each cassette is fully inserted.

CASSETTE CLOSE / CASH REPLENISHMENT

REMOVING THE REJECT VAULT

There are two (2) types of Reject vaults: lockable (standard) and open (optional). These procedures reference the standard lockable type.



Lockable reject vault.



Open (non-lockable) reject vault.

IMPORTANT!

If you remove the reject vault with power applied, the terminal will sense this and automatically reset the rejected note count to **ZERO**. Therefore, to ensure an accurate rejected note count **NEVER REMOVE THE REJECT VAULT WITH POWER APPLIED WITHOUT CHECKING FOR AND REMOVING ANY REJECTED NOTES.**

The reject vault is locked when it is removed from the dispensing mechanism. The color indicator shows a green window when the reject vault is opened for note collection (inside the dispensing mechanism) and when it is ready for use.

The color indicator shows a red window when the reject vault is inserted into the dispensing mechanism and until it is opened for rejected note retrieval.



1. To remove the reject vault, grasp the vault handle with one hand while holding the mechanism in place with the other hand. Pull the vault out slightly. Place one hand underneath to support the vault as you slide it completely out of the unit. Place it on a level surface.



MODEL RL5000 (X2) USER MANUAL

OPENING THE REJECT VAULT

The reject vault is locked when it is removed from the dispenser. A color indicator window shows **GREEN** when the vault is opened for collection and when it is ready for use. This condition is also referred to as the **PRIME** position of the color window.

The color window shows **RED** when the vault is inserted into the dispenser and will show **RED** until it has been removed from the dispenser and opened for collection.

Remove the vault seal (if applicable). Turn the small handle on the front *counterclockwise* and lift the lid. Release the handle. Collect the rejected notes.



Open reject vault top.

CLOSING THE REJECT VAULT

After removing any rejected notes, turn the small handle about a half-turn counterclockwise and close the lid. Allow the handle to return to the position of the seal bracket. At this point, the vault is primed and the color window should be showing **GREEN**. If applicable, apply a new vault seal and lock the small handle to the seal bracket.

INSTALLING THE REJECT VAULT

Slide the reject vault back into its slot in the mechanism. Make sure the vault is fully inserted. Close and lock the security container.

**REPLENISH CASSETTE(S)
(TDM-250)**

TDM Cassette(s) Replenishment

➡ Regardless of the number of cassettes in the TDM mechanisms, cash replenishment procedures are the same for each cassette.



TDM-250



TDM-250

REMOVING THE CURRENCY CASSETTE(S)

1. Unlock and open the security cabinet door.
2. Release the slide locking lever (if applicable) and extend the dispenser mounting tray fully (if applicable) as shown below.
3. To gain access to the cassette(s), rotate the mechanism mounting platform to the “SERVICE” position:
 - Locate the spring-loaded locking pin on the underside of the tray.
 - Pull the pin down to release the swivel mounting platform.



Pull release pin.

MODEL RL5000 (X2) USER MANUAL

- Grasp the Green-colored handle and slowly turn the tray *clockwise 180°* so that the note and reject cassette(s) can be accessed from the front of the unit.
- Release the locking pin and move the mounting platform back and forth slightly to ensure the pin snaps back into place, locking the mounting platform into the “SERVICE” position.



Rotate turntable 180°.

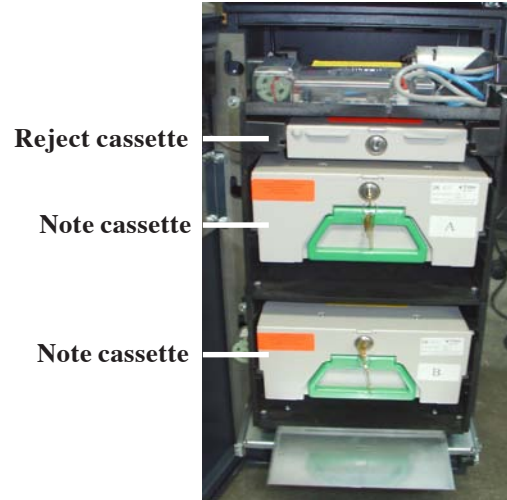

TDM in “Service” position.

4. To remove the note cassette(s), grasp the cassette handle and pull in a firm but controlled manner to release the cassette from the snap catches. Try to use only the minimum amount of force to release the cassette! The cassette will only move a few inches! Once released from the snaps, you can slide the cassette out of the mechanism. Place the cassette on a level, flat surface for replenishment.

CASSETTE CLOSE / CASH REPLENISHMENT

LOADING THE CURRENCY CASSETTE

1. Unlock and open the cassette lid using the supplied key. Move the pusher plate to the rear of the cassette (toward the handle).

Note: The pusher plate action will depend on the type of cassette in use. Some cassettes require you to maintain pressure on the pusher plate as needed while loading notes. Other cassettes use a locking mechanism to hold the packer plate in the loading position. On these cassettes, pull the pusher-plate all the way back to the handle end of the cassette and turn the key to latch the pusher plate into the loading position.



Unlock and open note cassette.



Pull the packer plate back. Cassettes allow the pusher-plate to be latched in position using the key-lock.

2. Count the number of bills that remain in the cassette, if any. Next, count the number of bills that are being added into the cassette.
3. Add the number of bills being placed into the cassette to the number that remained. The **“Total”** number of these bills will be entered in the **“ENTER CASSETTE QUANTITY”** option. Place the currency into the cassette between the pusher plate and front of cassette.
4. Hold the notes shown and turn the key-lock to release the catch. Allow the pusher plate to slowly compress the notes.

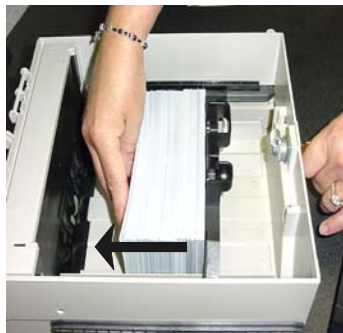

MODEL RL5000 (X2) USER MANUAL

5. Close and lock the cassette. Remove the key. Slide the cassette back into its compartment in the dispensing mechanism. Make sure the cassette is fully inserted! You will feel the cassette latch securely into the snap catches.

REMOVING THE REJECT CASSETTE

The reject cassette is located just above the currency cassette(s) in the dispensing mechanism. Follow these steps to remove the reject tray:

1. Slide the reject cassette out of its compartment in the dispensing mechanism. Place the tray on a flat surface.
2. Unlock the tray using the supplied key. Flip the top back to gain access to the reject compartment.



3. Remove any notes in the reject compartment. Close and lock the reject tray. Remove the key. Slide the cassette back into its compartment in the dispensing mechanism. Make sure the reject cassette is fully inserted! You will feel the cassette snap securely into the catches.

***Note:** You may wish to record the denomination and number of notes removed from the reject tray for use when balancing the note tray against the cassette/day close records.*

ROTATE DISPENSER MECHANISM

1. After reinstalling the currency and reject cassettes, pull down on the swivel platform locking pin to allow the swivel platform to turn.
2. Rotate the mechanism *counterclockwise 180°* back to the “OPERATE” position. (TDM-150/200/250) - Push the mounting tray back into the security cabinet

SECTION 4
GENERAL MAINTENANCE

MODEL RL5000 (X2) SERIES USER MANUAL

INTRODUCTION

This section of the manual covers preventive and corrective maintenance procedures appropriate for user personnel. The following areas are covered:

1. **REPLENISHING RECEIPT PAPER.** Describes how to replace a spent receipt paper roll.
2. **CLEANING THE ENCLOSURE.** The proper way to clean the ATM housing.
3. **CARD READER CLEANING.** The recommended card reader cleaning technique.

Important

Only qualified service personnel are authorized to repair or service the terminal. Should a malfunction occur, DO NOT attempt to service the unit yourself! Contact your Triton certified service provider!

REPLENISHING THE RECEIPT PAPER

NOTE: This operation must be completed with the AC power applied to the ATM.

1. Open the control panel by unlocking the top enclosure and pulling the hinged door forward.
2. If paper remains on the roll, cut or tear the paper between the roll and the printer.
3. Remove the existing paper and spindle from the paper bracket.



Cut paper between roll and paper path

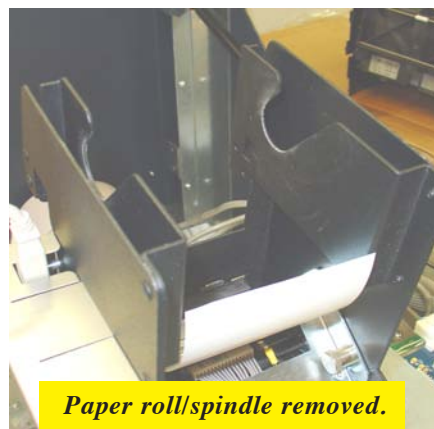

Paper roll/spindle removed.

GENERAL MAINTENANCE

**** CAUTION ****

DO NOT pull receipt paper backwards through the printer with the tension rollers closed!

This may leave paper fragments that can cause paper jams.

4. Pull the pin located on the right side of the printer bracket shown. Rotate the printer/cutter assembly towards the front of the control panel.
5. Release (**OPEN**) the blue tension lever located on the left side. Remove any paper from the printer/cutter assembly. Move the tension lever back to the **CLOSED** position (blue lever facing towards the right). Close the printer/cutter assembly by rotating up and pin secures.

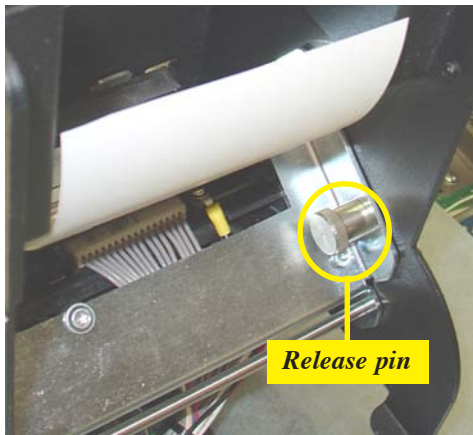

Pull release pin.



Rotate printer/cutter assembly down.

Tension lever.

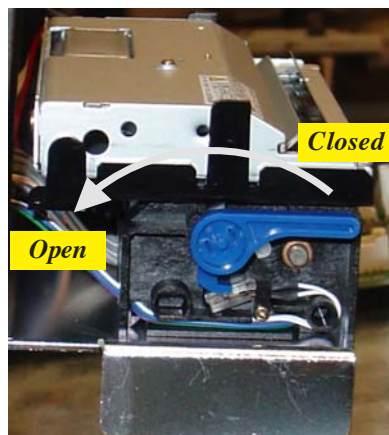

MODEL RL5000 (X2) SERIES USER MANUAL

6. Install the new paper roll on the spindle. Unwind enough paper to ensure the glued end that secured the paper roll is removed.
7. Place the paper roll (w/spindle) on the paper support bracket by sliding ends of spindle on to the bracket.

*Note: The spindle is inserted so that the paper will feed from the **TOP** of the roll when it is installed on the paper bracket.*

NOTE

Triton recommends the use of 20# thermal printer paper (Triton P/N 05403-00053). This receipt paper has been shown to improve performance and reliability.



Paper roll installed in bracket.

8. Feed the end of the paper into the printer take-up slot. *Note: Paper feeds **Over the bar**.* The printer will activate and automatically feed the paper through the printer and slightly out the front of the control panel.



Feed paper into the printer take-up slot.

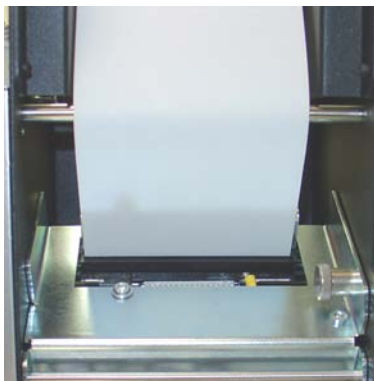

Receipt paper installed



Paper feeds automatically out front of unit.

9. If the printer does not feed automatically, open the printer/cutter assembly and check the blue tension lever for the correct (**Closed**) position.
10. Close and lock the control panel. Go to **MANAGEMENT FUNCTIONS > DIAGNOSTICS** and perform a **RESET/TEST PRINTER**.

GENERAL MAINTENANCE

CLEANING THE ENCLOSURE

The ATM front panel is highly durable, resisting scratches and finger smudges. However, occasional cleaning of the front panel and the plastic enclosure may be desirable. A soft dry or slightly damp cloth may be used for cleaning. For best results, use a weak solution of a mild detergent and water.

**** Caution ****

**Avoid using abrasive cleaners on any surface of the terminal.
Do not spray liquid cleaner directly on the unit.**

CLEANING THE DISPLAY

The Liquid Crystal Display (LCD) on the front of the ATM has a plastic protective window that should be cleaned only with a soft cloth, dampened with a weak solution of a mild detergent and water.

**** Caution ****

**Do not use any abrasive cleaners on the window as it will scratch.
Do not spray liquids onto the screen as they may run down inside the unit and cause damage.**

CARD READER CLEANING

Special cleaning cards (P/N 06200-00055) are available for proper maintenance of the card reader. The reader should be cleaned at least once a month by inserting and removing a cleaning card, as shown below. It may be necessary to clean the card reader more often in locations that see heavy usage.

1. Remove the cleaning card from the sealed pouch.
2. Insert the cleaning card into the card reader and move in and out several times.
3. Remove the cleaning card and turn over to use other side.
4. Insert again several times.
5. Remove cleaning card and discard.

THIS PAGE INTENTIONALLY LEFT BLANK

APPENDIX A
SOFTWARE LICENSE AGREEMENT

MODEL RL5000 (X2) USER MANUAL

AUTOMATED TELLER MACHINE (“ATM”) SOFTWARE END-USER AGREEMENT

IMPORTANT: PLEASE READ CAREFULLY:

BY INSTALLING OR OTHERWISE USING THE ATM, YOU (AS THE OWNER OR LESSEE OF THE ATM), AGREE TO BE BOUND BY THE FOLLOWING TERMS AND CONDITIONS, INCLUDING, WITHOUT LIMITATION, THE WARRANTY DISCLAIMERS, LIMITATIONS OF LIABILITY AND TERMINATION PROVISION WHICH APPLY TO YOUR USE OF THE ATM SOFTWARE CONTAINED IN THIS ATM AND IS HEREBY LICENSED BY TRITON SYSTEMS OF DELAWARE, INC. (“Triton”) TO YOU PURSUANT TO THIS AGREEMENT.

IF YOU DO NOT AGREE TO OR ARE NOT WILLING TO BE BOUND BY THE TERMS AND CONDITIONS OF THIS AGREEMENT, DO NOT INSTALL OR OTHERWISE USE THIS ATM AND PROMPTLY CONTACT YOUR VENDOR. INSTALLING OR OTHERWISE USING THE ATM INDICATES THAT YOU ACCEPT THESE TERMS.

This ATM is manufactured by, and utilizes proprietary software owned by Triton Systems of Delaware, Inc. and/or its suppliers. All right, title and interest in and to all component software installed or embedded in the ATM (“ATM Software”) including all associated intellectual property rights, are and will remain the property of Triton and/or its suppliers.

LICENSE: Triton grants you a limited, nonexclusive license to use the ATM Software but only in connection with the operation of this ATM subject to the terms and restrictions set forth in this License Agreement. You are not permitted to use the ATM Software in any manner not expressly authorized by this License. You acknowledge and agree that ownership of the ATM Software and all subsequent copies thereof regardless of the form or media are held by Triton or its suppliers.

The software is licensed for use on this specific Triton ATM product and may not be used on any other product. Otherwise, the supporting documentation, if any, may be copied only as essential for backup or archive purposes in support of your use of the ATM. You must reproduce and include all copyright notices and any other proprietary rights notices appearing on any copies that you make.

ASSIGNMENT: NO REVERSE ENGINEERING: You may transfer the ATM Software to another party but only in connection with a transfer of all your right, title and interest in and to this ATM and if such party accepts the terms and conditions of this License Agreement. If you transfer the ATM, you must at the same time transfer the supporting documentation, if any, to the same party or destroy any such materials not transferred. Modification, reverse engineering, reverse compiling, or disassembly of the ATM and/or the ATM Software is expressly prohibited.

APPENDIX A - SOFTWARE LICENSE AGREEMENT

DISCLAIMER OF WARRANTIES AND LIMITATION OF DAMAGES:

TO THE EXTENT PERMITTED BY LAW, THIS ATM SOFTWARE, INCLUDING ALL INCORPORATED THIRD PARTY SOFTWARE, AND DERIVATIVES IS PROVIDED, "AS IS". TRITON MAKES NO REPRESENTATIONS WITH RESPECT TO, AND DOES NOT WARRANT THE PERFORMANCE OR RESULTS YOU OR YOUR CUSTOMERS MAY OBTAIN BY USING THE ATM. TRITON SPECIFICALLY DISCLAIMS ANY AND ALL WARRANTIES, EXPRESS, IMPLIED OR STATUTORY, INCLUDING WITHOUT LIMITATION, WARRANTIES OF QUALITY, PERFORMANCE, NON-INFRINGEMENT, AND MERCHANTABILITY OR FITNESS FOR ANY PARTICULAR PURPOSE.

TRITON MAKES NO REPRESENTATIONS OR WARRANTIES AND ASSUMES NO OBLIGATIONS TO YOU OR YOUR CUSTOMERS WITH RESPECT TO ANY TRANSACTION OR SERVICES ACCESSED AND/OR UTILIZED IN CONSUMER-INITIATED TRANSACTIONS MADE FROM THIS ATM. IN NO EVENT WILL TRITON, ITS AFFILIATES, DIRECTORS, OFFICERS, EMPLOYEES, AGENTS OR SUPPLIERS BE LIABLE TO YOU UNDER ANY THEORY OF TORT, CONTRACT, STRICT LIABILITY OR OTHER LEGAL OR EQUITABLE THEORY FOR ANY PUNITIVE, CONSEQUENTIAL, INCIDENTAL, SPECIAL OR SIMILAR DAMAGES, INCLUDING ANY LOSS PROFITS OR LOST SAVINGS, EVEN IF A TRITON AGENT OR REPRESENTATIVE HAS BEEN ADVISED OF THE POSSIBILITY OF SUCH DAMAGES, OR FOR ANY CLAIM BY ANY THIRD PARTY.

YOUR SOLE REMEDY AGAINST TRITON FOR DEFECTIVE PERFORMANCE OF THE ATM SOFTWARE WILL BE LIMITED EXCLUSIVELY TO REPAIR OR REPLACEMENT OF THE ATM AND/OR THE ATM SOFTWARE, AT TRITON'S SOLE DISCRETION.

Any warranty pertaining to the ATM, its mechanical components exclusive of the ATM software, shall be governed and controlled by any warranty given to you by Triton in a separate document accompanying this ATM.

The foregoing limitation of liability and exclusion of certain damages will apply regardless of the success or effectiveness of other remedies.

GOVERNING LAW: This License Agreement shall be governed by the laws of the State of Mississippi and by the laws of the United States, excluding their conflicts of laws principles.

SEVERABILITY: In the event any provision of this License Agreement is found to be invalid, illegal or unenforceable, the validity, legality and enforceability of any of the remaining provisions shall not in any way be affected or impaired.

ENTIRE AGREEMENT: This License Agreement and the accompanying Limited Warranty set forth the entire agreement between you and Triton, supersedes all prior agreements, whether written or oral, with respect to the ATM Software, and may be amended only in writing signed by both parties.

THIS PAGE INTENTIONALLY LEFT BLANK

APPENDIX B
WARRANTY STATEMENT

MODEL RL5000 (X2) USER MANUAL

WARRANTY STATEMENT

Manufacturer warrants that the Products delivered to Distributor will perform in accordance with the Manufacturer's published specifications, and as outlined in the Manufacturer's booklet entitled "Thirteen Months Parts Only Limited Warranty" for thirteen months from date of shipment in Long Beach, MS. Distributor acknowledges that it has received a copy of such booklet, that it has read its entirety and that it understands and agrees with its contents.

Manufacturer's warranty shall not apply to any damage resulting from abuse, negligence, accident, or to any loss or damage to the products while in transit.

Written notice and explanation of circumstances surrounding any claims that the goods have proved defective in material or workmanship shall be given promptly from the distributor to the manufacturer. No claim may be made, or action brought, by or through a distributor after the expiration of 14 months following any alleged breach of warranty.

DISTRIBUTOR'S SOLE AND EXCLUSIVE REMEDY IN THE EVENT OF DEFECT IS EXPRESSLY LIMITED TO THE REPLACEMENT OR CORRECTION OF SUCH DEFECTIVE PARTS BY MANUFACTURER AT ITS ELECTION AND SOLE EXPENSE, EXCEPT THERE SHALL BE NO OBLIGATION TO REPLACE OR REPAIR ITEMS WHICH, BY THEIR NATURE, ARE EXPENDABLE. If Manufacturer is unable to replace or repair the defective parts, Manufacturer shall refund to Distributor that portion of the purchase price allocable pays to such goods.

No representation or other affirmation of fact not set forth herein, including but not limited to statements regarding capacity, suitability for use, or performance of the goods, shall be or be deemed to be a warranty or representation by Manufacturer for any purpose, nor give rise to any liability or obligation of Manufacturer whatever.

EXCEPT AS SPECIFICALLY PROVIDED IN THIS DOCUMENT, THERE ARE NO OTHER WARRANTIES EXPRESSED OR IMPLIED INCLUDING, BUT NOT LIMITED TO, ANY IMPLIED WARRANTIES OR MERCHANTABILITY OR FITNESS FOR A PARTICULAR PURCHASE.

LIMITATION OF LIABILITY

IN NO EVENT SHALL MANUFACTURER BE LIABLE FOR LOSS OF PROFITS OR INCIDENTAL, INDIRECT, SPECIAL, CONSEQUENTIAL OR OTHER SIMILAR DAMAGES ARISING OUT OF ANY BREACH OF THIS CONTRACT OR OBLIGATIONS UNDER THIS CONTRACT.

DEFENSE OF INFRINGEMENT CLAIMS

If notified promptly in writing of any action (and all prior claims relating to such action) brought against the Distributor based on a claim that Distributor's use of the goods infringes a patent or other intellectual property right, and if given access by Distributor to any information distributor has regarding such alleged infringement, Manufacturer agrees to defend Distributor in such action at its expense and will pay any costs or damages finally awarded against Distributor in any such action, provided the Manufacturer shall have had sole control of the defense of any such action and all negotiations for its settlement or compromise.

APPENDIX B - WARRANTY STATEMENT

In the event that a final injunction shall be obtained against the Distributor's use of the goods or any of their parts by reason of infringement of a patent or other intellectual property right or if in Manufacturer's opinion the goods are likely to become the subject of a claim of infringement of a patent or other intellectual property right, Manufacturer will, at its option and at its expense, either procure for the Distributor the right to continue using the goods, replace or modify the same so they become non-infringing or grant the Distributor a credit for such goods as depreciated and accept their return. The depreciation shall be an equal amount per year over the lifetime of the goods as established by Manufacturer.

Manufacturer shall not have any liability to the Distributor under any provision of this clause if any infringement, or claim thereof, is based upon: (i) the use of the goods in combination with other goods or devices which are not made by Manufacturer; (ii) the use of the goods in practicing any process; (iii) the furnishing to the Distributor of any information, data, service, or applications assistance; or (iv) the use of the goods with modifications made by the Distributor. The Distributor shall hold Manufacturer harmless against any expense, judgment or loss for infringement of any patent or other intellectual property right which results from Manufacturer's compliance with the Distributor's designs, specifications or instructions. No costs or expenses shall be incurred for the account of Manufacturer without the written consent of Manufacturer. **THE FOREGOING STATES THE ENTIRE LIABILITY OF MANUFACTURER WITH RESPECT TO INFRINGEMENT OF PATENTS OR OTHER INTELLECTUAL PROPERTY RIGHT BY THE GOODS OR ANY PART THEREOF, OR BY THEIR OPERATION.**

INTERPRETATION AND OTHER PAROLE EVIDENCE

This writing is intended by the parties as final expression of their agreement and is intended also as a complete and exclusive statement of the terms of their agreement. No course of prior dealing between the parties and no usage of the trade shall be relevant to supplement or explain any term used in these terms and conditions. Acceptance or acquiescence in a course of performance rendered under these terms and conditions shall not be relevant to determine the meaning of these terms and conditions even though the accepting or acquiescing party has knowledge of the performance and opportunity for objection. Whenever a term defined by the Uniform Commercial Code, as adopted in Mississippi, is used in these terms and conditions, the definition contained in the code is to control.

MODIFICATIONS

These terms and conditions can be modified or rescinded only by writing signed by both the parties or their duly authorized agents.

WAIVER INEFFECTIVE

No claim or right arising out of or relating to a breach of these terms and conditions can be discharged in whole or in part by a waiver or renunciation of the claim or right unless the waiver or renunciation is supported by consideration and is in writing signed by the aggrieved party. Waiver by either Manufacturer or Distributor of a breach by the other of any provision of these terms and conditions shall not be deemed a waiver of future compliance therewith, and such provisions shall remain in full force and effect.

MODEL RL5000 (X2) USER MANUAL

STATUTE OF LIMITATIONS

Any action by the Distributor or Manufacturer for breach of these terms and conditions must be commenced within one (1) year after the cause of action has accrued.

APPLICABLE LAW

These terms and conditions shall be governed by and construed in accordance with the provisions of the Uniform Commercial Code as adopted by the State of Mississippi.

BANKRUPTCY

In the event of any proceedings, voluntary or involuntary, in bankruptcy or insolvency by or against Distributor, or in the event of the appointment, with or without the Distributor's consent, of an assignee for the benefit of creditors or of a receiver or of a liquidator, then Manufacturer shall be entitled to cancel any unfilled part of these terms and conditions without any liability whatsoever.

PARTS ONLY LIMITED MANUFACTURER'S WARRANTY

Triton Systems of Delaware, Inc. warrants the components of each RL2000 ATM, excluding software and related documentation, against any defect in materials and/or workmanship for a period of 13 months from the shipping date. If a component fails due to defects in materials and/or workmanship within the warranty period, Triton will furnish a new or refurbished component, at its discretion. Triton shall not be responsible for labor or other costs associated with installing the components and the failed component shall be returned to Triton at the purchaser's expense. Triton shall not be responsible for misuse or abuse of a unit and any attempts to remove or deface the serial number or date code on a unit or any component thereof, or any attempt to repair a unit or to repair or replace any component by anyone other than a service technician authorized by Triton shall void this warranty.

Limited Warranty covers normal use. Triton does not warrant or cover damage:

- occurring during shipment of the equipment or components from or to Triton's facilities;
- caused by accident, impact with other objects, dropping, falls, spilled liquids, or immersion in liquids;
- caused by a disaster such as fire, flood, wind, earthquake, lightning, or other acts of God;
- caused by failure to provide a suitable installation environment for the equipment, including but not limited to, faulty wiring in the building in which the equipment is installed, installation in a facility with uncontrolled environmental conditions, failure to provide a dedicated electrical circuit on which the equipment operates, and/or lack of proper earth grounding for the equipment;
- caused by the use of the equipment for purposes other than those for which it was designed;
- resulting from improper maintenance;
- caused by any other abuse, misuse, mishandling, or misapplication.

Under no circumstances shall Triton or its suppliers be liable for any special, incidental, or consequential damages based upon breach of warranty, breach of contract, negligence, strict liability, or any other legal theory. Such damages include, but are not limited to, loss of profits, loss of revenue, loss of data, loss of use of the equipment or any associated equipment, cost of capital, cost of substitute or replacement equipment, facilities or services, downtime, purchaser's time, the claims of third parties, including customers, and injury to property.

APPENDIX B - WARRANTY STATEMENT

DISCLAIMER OF WARRANTIES

The warranty stated above is the only warranty applicable to this product. All other warranties, expressed or implied (including all implied warranties of merchantability or fitness for a particular purpose or quality of service), are hereby disclaimed. No oral or written information, or advice given by Triton, its agents or employees shall create a warranty or in any way increase the scope of this warranty.

SHIPPING DAMAGE

All equipment is shipped Free On Board (FOB), Triton's facilities. The organization or individual who has purchased the equipment assumes responsibility for the equipment once it leaves Triton's facilities.

Should your equipment be damaged in the process of shipment or delivery to your place of destination, we recommend the following course of action:

- If possible, call the shipping company before the driver leaves your delivery site. Make note of the damage on the "receipt of delivery" paperwork. If this is not possible, call them as soon as possible to report the damage.
- Take photographs of the damaged packaging prior to opening the boxes. If this is not possible, make note of key points, such as whether the equipment is on a pallet, if the banding is intact, how the boxes are damaged, etc. Keep all of the packaging for inspection by the shipping company.
- If you unpack the equipment, take photographs of the damaged equipment. If this is not possible, make note of the damages.
- You must file a claim with the shipper for shipping damages immediately after reporting the damages.

Should you specify the carrier, we recommend that you explore with this chosen carrier the policies and procedures regarding shipping damage claims prior to selecting them as your preferred carrier.

If the equipment receives structural damage and is in an un-installable condition, Triton will work with you to arrange for a replacement unit to be shipped as soon as possible. The purchaser will be billed for the replacement unit. Triton's repair technicians will repair the damaged unit after it is returned to our facilities. We will credit the purchaser's account for the full purchase price of the damaged unit, minus the cost of returning the unit to "like new" condition. Under no circumstances does Triton authorize anyone to complete structural damage repairs in the field. Therefore, we will not ship primary structural parts, such as a cabinet head or main cabinet body for repair in the field.

MODEL RL5000 (X2) USER MANUAL

AUTHORIZED INSTALLATION AND SERVICE PROVIDERS

Triton utilizes several nationwide and regional authorized third party maintenance providers. Triton recommends all ATMs be installed and serviced by service technicians certified by Triton. This includes authorized third party service technicians and technicians who have been factory trained by Triton to service ATM equipment. Installation or repairs attempted by unauthorized service technicians may void the warranty or warranty claims denied on the product.

Please contact Triton's Technical Services department at (800) 259-6672 for a list of our third party service providers and/or to obtain information on the requirements and procedures for becoming a certified Triton service technician.

TRITON'S TECHNICAL SERVICES DEPARTMENT

The primary purpose of the Technical Services department is to provide assistance to customers in the operation, trouble shooting, and repair of equipment manufactured by Triton. A toll-free phone number (1-800-259-6672) is provided for convenience. The Technical Services department operates to serve our customers. The staff is trained to follow our policies and procedures to ensure fair and uniform treatment of all our customers.

AUTOMATED VOICE MAIL SYSTEM

Our goal is to have a 'live' person answer 100% of all incoming calls (during regular support hours). On occasion, however, call loads may exceed the capacity of the staff. When this occurs, an automated voice mail system will answer the call, indicate to the caller that all Technical Support specialists are busy assisting others, and ask the caller to leave detailed information about the nature of the call.

Should it become necessary to leave a voice mail message, the caller should state:

- their name,
- the organization for which they work,
- the **serial number** of the equipment they are calling about,
- detailed description of the problem that they are experiencing, and
- phone number where they can be reached, including area code.

As Technical Support specialists become available, they check for voice mail messages and return calls in the order in which they were received. By providing the information requested in the voice mail, the technician can be prepared when your call is returned. Triton asks you to be patient if you must leave voice mail and assures you that your call is important to us and that we will respond promptly.

APPENDIX B - WARRANTY STATEMENT

CALLS FOR SERVICE OR REPAIR

Calls for service or repair will be accepted from authorized service technicians only. End users must contact either the sales organization that placed the equipment or an authorized third party service organization to obtain service. The sections that follow describe the policies and procedures that relate to the repair and replacement of malfunctioning equipment.

QUESTIONS ON OPERATION OF EQUIPMENT

Technical support is available to owners of Triton equipment and to qualified service personnel. When calling for help with the configuration or operation of a Triton product, the caller must provide either positive identification as a service technician or the serial number of a Triton terminal. Technical support is provided during normal business hours for the life of the product.

When calling for help with an operational problem, please have available information pertaining to the nature of the trouble. This includes the type of equipment, examples of what is or is not happening, and the name of the processor that supports your terminal.

All questions pertaining to the settlement of accounts, transaction inquiries, and fund status must be directed to the processor. Triton does not have access to the information needed to answer questions relating to specific transactions.

CONTACT INFORMATION

Triton Systems of Delaware, Inc.
522 East Railroad Street
Long Beach, MS 39560

SALES:

1 (800) 367-7191
1 (228) 868-1317
1 (228) 868-0437 (Fax)

SERVICE:

1 (800) 259-6672 (Technical Support)
1 (228) 575-3229 Fax (Technical Support)
1 (228) 868-0859 Fax (Parts)

THIS PAGE INTENTIONALLY LEFT BLANK



APPENDIX C COMBINATION LOCKS



MODEL RL5000 (X2) USER MANUAL

INTRODUCTION

The security cabinet can be secured using an electronic combination locks. This appendix covers how to change the combination of either lock. Procedures specific to the electronic lock, such as changing the battery, are also covered.

OPERATING THE ELECTRONIC LOCK (LAGARD)

The electronic lock combination consists of six digits. Upon arrival, the combination of the lock should already be preset to **1-2-3-4-5-6**.

ENTERING THE COMBINATION

1. Enter the preset combination and check for proper operation. After each keypress, the lock will beep. After the final digit has been entered, the lock will beep **twice**, and the open period will begin.
2. When a valid combination has been entered, the operator will have approximately **4 seconds** to open the lock.
3. To open the lock, turn the **dial** clockwise.
4. After the lock is opened, the cabinet door may be opened.

LOCKOUT FEATURE

The lock includes a '**Wrong Try Penalty**' lockout feature that prevents entry from unauthorized personnel. This feature performs as follows:

- Entry of four (4) consecutive invalid combinations starts a 5-minute delay period.
 - LED flashes red at ten (10) second intervals.
- At the end of the delay period, two (2) more consecutive invalid combinations will restart an additional 5-minute delay.

CHANGING THE COMBINATION

To change the combination of the lock, simply follow these directions.

1. Enter **six (6) zeros '0'**.
2. Enter the **current** combination (initially set at 1-2-3-4-5-6).
3. Enter the **new** six (6) digit combination **twice**.
 - If a mistake is made, wait thirty (30) seconds and repeat the first 3 steps.
4. Test lock combination several times before closing the door. The combination is now changed.

Valid Code Entry - Double signal after valid six (6) digit code is entered.

Invalid Code Entry - Triple signal and old code is still valid.

APPENDIX C - COMBINATION LOCKS

BATTERY LOW WARNING

Repeated beeping during an opening indicates that the battery is low or dead and needs to be replaced. The battery box is located on the inside of the door.

Note: If the lock will not operate (i.e. repeated beeping or no beeping) while the door is closed and locked, the battery must be energized from the two external terminals on the front of the push-button panel.

To energize the lock, connect a 9-volt alkaline battery on the external terminal points. Maintain contact, enter a valid combination, and turn the dial clockwise to open the lock.

Note: *You must maintain battery contact at all times throughout this procedure.*

CHANGING THE BATTERY

1. Open the ATM vault door. Remove the battery box cover by pulling the front portion away from the vault door.
2. The connector is easily removed by unsnapping it from the two (2) terminal on the top of the battery.
3. Remove the old battery. Install/connect a new 9-volt alkaline battery.
4. Push the battery and the leads completely up into the battery compartment.
5. Reinstall the cover and test the unit several times before closing the vault door.

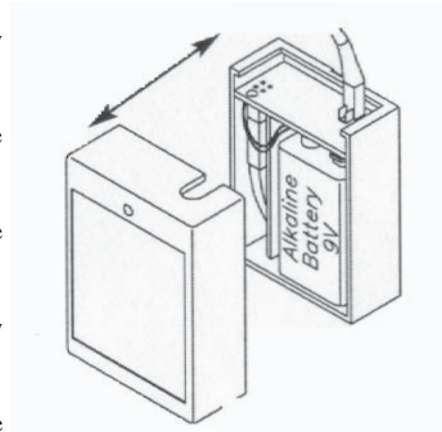

MODEL RL5000 (X2) USER MANUAL

OPERATING THE ELECTRONIC LOCK (KABA MAS)

Each lock is shipped from the factory in Shelved Mode, operating on a standard combination (**50-25-50**).

ENTERING THE COMBINATION

1. Turn the dial left (CCW) until the letters “EC” (Enter Combination) appear on the LCD.
2. Enter the factory combination of 50-25-50 by sequentially pressing those six (6) buttons. The LCD will display these numbers as they are entered.
3. When the combination has been correctly entered, the LCD will read “OPr”, meaning “OPen right”. Turn the dial right (CW) until it stops. The locks bolt is now retracted and the lock is open.
4. After the lock is opened, the cabinet door may be opened.

TO CHANGE THE COMBINATION:

1. Power Lock - EC

Turn the dial to the left (CCW) until “EC” (Enter Combination) is displayed.

2. EC - Enter Shelved Mode Combination - OPr

Enter the current combination (either 50-25-50 or a changed combination) by sequentially pressing those digits on the lock keypad. The numbers will be displayed on the LCD as they are entered.

3. OPr - Retract Bolt

Turn the Dial to the right (CW) to retract the bolt

4. Open Door

5. Insert Change Key

Insert the change key into the change key socket on the back of the lock.

6. Extend Bolt

Turn the Dial to the left (CCW) to extend the bolt. Do not close the door

7. Power Lock - \downarrow EC

Turn the dial to the left (CCW) until \downarrow EC (the Change Key symbol along with Enter Combination) is displayed.

8. \downarrow EC - Press #8 - EcF

Press the “#” button followed by the “8” button. EcF (Enter combination,Factory) will be displayed.

9. EcF - Enter Current Shelved Mode Combination - EnF

Enter the current shelved mode combination, “EnF” (Enter new Factory combination) will be displayed

10. EnF - Enter New Combination - Cnf

Select and enter the new combination. “CnF” (Confirm new Factory combination) will be displayed.

11. Cnf - Enter New Combination - POC

Enter new combination again to confirm. POC (Pull Out Change key) will be displayed.

12. POC - Remove Change Key - EOP

Remove the change key. EOP (End Operation) is displayed.

APPENDIX C - COMBINATION LOCKS

13. EOP - Power Lock - EC

Turn the dial to the left (CCW) until EC (Enter Combination) is displayed.

14. EC - Enter New Shelved Mode Combination - OPr

Enter the new shelved mode combination by pressing those digits on the lock's keypad. The numbers will be displayed on the LCD as they are entered.

15. OPr - Retract Bolt

Turn the dial to the right (CW) to retract the bolt.

16. Close Door

17. Extend Bolt

Turn the dial to the left (CCW) to extend the bolt.

CODE DESCRIPTIONS:

1. "EC" = ENTER COMBINATION
2. "EC" = (CHANGE) KEY ENTER COMBINATIONS
3. "D-" = DELAY TIME
4. "INI" = DISPLAYS WHILE LOCK IS BEING INITIALIZED
5. "IP1" = INSERT PERSONAL IDENTIFIER 1
6. "IP2" = INSERT PERSONAL IDENTIFIER 2
7. "ISA" = INSERT SUPERVISOR AUDIT KEY
8. "POC" = PULL OUT CHANGE KEY
9. "OPR" = OPEN RIGHT
10. "CC" = CONFIRM COMBINATION
11. "EC2" = ENTER COMBINATION 2
12. "C00" = CLOSE SEAL NUMBER
13. "EOP" = END OPERATION
14. "Z" = (ERROR LIGHTNING BOLT)
15. "AUD" = DISPLAYS WHILE AUDIT DATA IS BEING WRITTEN
16. "?-" = DISPLAYS WHEN # HAS BEEN PRESSED TO ENTER A KEYPAD COMMAND

THIS PAGE INTENTIONALLY LEFT BLANK

APPENDIX D
TRITON DISPENSING MECHANISM
“BACKGROUND PAPER”

MODEL RL5000 (X2) USER MANUAL

BACKGROUND PAPER

TRITON DISPENSING MECHANISM (TDM)

1. The TDM dispenser family was designed and built to provide quality performance with minimum service. In 2005, Triton released two new versions of TDM dispensing mechanisms: the TDM-2XX multi-cassette family and a modified version of the TDM-1XX that included the features and improvements of the multi-cassette models.
2. The TDM-1XX modified dispenser mechanisms include a DC drive motor to replace the stepper motor for added control and a new pulley system that increases speed for improved note delivery. Changes in the diverter belt idler rollers and new belt material extend the life of the mechanism. The modified dispenser includes more self-diagnostic capability, expanded hardware error reporting to include cable disconnects, and an enhanced timing sequence to minimize jams. Firmware changes have made possible higher operation speeds and faster internal diagnostics.
3. There are two versions of TDM-1XX dispensers currently available, TDM-100/150 mechanisms produced before May 2, 2005 and the TDM Modified used in production since that date. A quick visual check of the drive motors can help determine the dispenser type and is illustrated in the photos below. The original TDM dispenser will have a black encased stepper motor installed next to the dispenser mainboard. The DC drive motor on the TDM modified is silver in color.

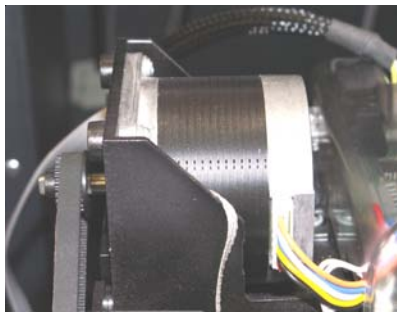

Stepper Motor from original TDM-1XX



DC drive motor from TDM-1XX modified

- a. The DC drive motor used on the TDM-1XX modified will allow more efficient operation over the life of the product. This motor has a different sound than the stepper motor previously produced. One characteristic of this motor, though not readily noticeable in all of them, is the potential to produce a clicking sound not heard with the stepper motors. This has led some customers to believe there might be a problem with the dispenser. With the cabinet door closed this sound should not be immediately noticeable by ATM customers.

APPENDIX D - TDM BACKGROUND PAPER

- b. Severe noise from any dispenser is an indication that a malfunction has occurred. If this happens you should examine the mechanism to determine the problem. Severe noise is normally caused by a drag on the mechanism, most likely from a shaft that has been pushed out of position causing the belt to “skip” on a pulley. This skipping is normally evident on the first two pulleys after the drive motor. In most cases the problem can be resolved by snapping the shaft back into position and if necessary replacing the top two drive belts. The part number for the belt replacement kit is 06100-00322 (TDM Belt Replacement Kit). See table below for kit breakdown.

TDM Belt Replacement Kit (P/N 06100-00322) Tools Required: #20 Torx driver / Phillips screwdriver			
Part Number	Description	Motor Type	Mechanism(s) Affected
03114-00001	Belt, Upper (short)	All	All listed below
04006-01001	Belt, Drive Motor (long)	DC (Stepper)	TDM-100 (w/o Billfish) TDM-150 (w/o Billfish)
04006-01003	Belt, Drive Motor (long)	DC (w/timing wheel)	TDM-100 (w/ Billfish) TDM-150 (w/ Billfish) TDM-200 (all) TDM-250 (all)
07100-00057	TDM Belt Replacement Procedures		

4. The pick mechanism for the TDM is located in the cassette. Failure to pick properly can cause the mechanism to exhibit symptoms of other dispenser errors.

As with any electro-mechanical device, there will be occasions when a malfunction or physical damage occurs and a repair is required. Failure to pick properly can cause the mechanism to exhibit symptoms of other dispenser errors. To accurately diagnose these errors it is necessary to have the mechanism and cassette operating together as a unit.

- a. If it becomes necessary to return a TDM dispenser to Triton for repair or replacement, the **Mechanism, Cassette(s), and Reject must be returned as a complete unit.**
- b. TDM dispensers can not be ordered as advanced replacement parts without the cassette and reject. RMAs for return will now include all three items. Failure to return the mechanism, cassette and reject together could result in repair or credit delays.

MODEL RL5000 (X2) USER MANUAL

OPENING THE ACCESS DOORS

1. The access doors allow you to check for jammed notes at key points in the feed path. The figures below shows the location of the lower, middle, and upper access doors on the front of the mechanism and the inner door located on the inside of the the dispenser (note and reject cassette(s) have been removed).

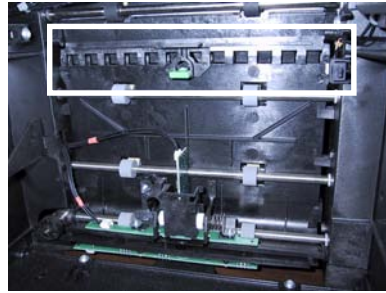
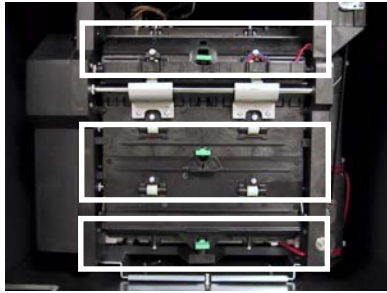

2. Each door is held closed using a *plastic fastener knob (now WHITE in color)*. Note the position of the knob when a door is locked: the knob is *Horizontal* as shown in figure below.

3. To unlock a door, grasp that door's knob and **GENTLY** turn it a quarter-turn to the left or right (to the Vertical position shown in figure below). This will allow the door to be opened so any stuck/jammed notes can be retrieved.

LOCKED

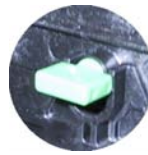

UNLOCKED



4. Carefully lift the door(s) to expose the feed path and remove any notes. Close the door. Apply gentle pressure to the door to hold it in place and **GENTLY** twist the **fastener** a quarter-turn to the left or right to lock the door in place.

Knob shown in LOCKED and UNLOCKED Positions.

**** CAUTION ****

The plastic fasteners ARE NOT HANDLES! They may pull out if you grasp them as such. Also, DO NOT force the knob to lock/unlock. You may break or damage!

SUPPLEMENT A
T5 AND T7 PCI-EPP
BATTERY REPLACEMENT PROCEDURES

T5 PCI-EPP BATTERY REPLACEMENT

**** CAUTION ****

You must not remove battery from EPP without FIRST connecting a new battery! This EPP will be permanently damaged if unpowered and battery is removed before connecting a new battery!

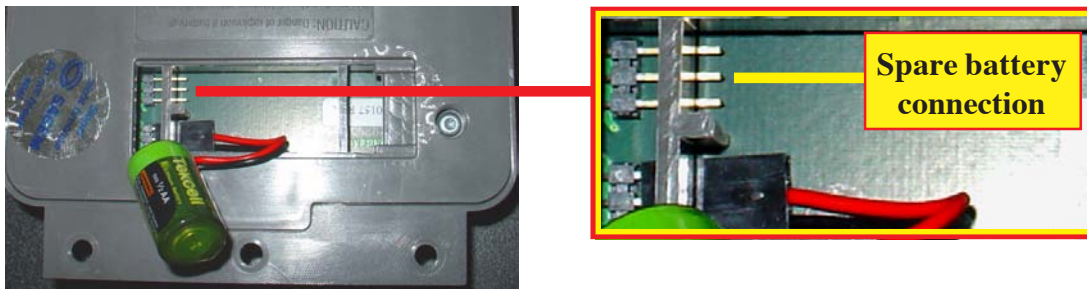

EXISTING BATTERY - DO NOT REMOVE BEFORE CONNECTING A SPARE BATTERY FIRST!

The spare battery for the T5 PCI-EPP may be purchased from Triton Systems:
P/N 01300-00025 (T5 PCI-EPP Lithium Backup Battery)

T7 PCI-EPP BATTERY REPLACEMENT

*** IMPORTANT ***

You may remove the battery without risk of damage to the EPP. You have approximately 2-5 minutes to replace with a spare battery before losing the data stored (keys, passwords) in the keypad.

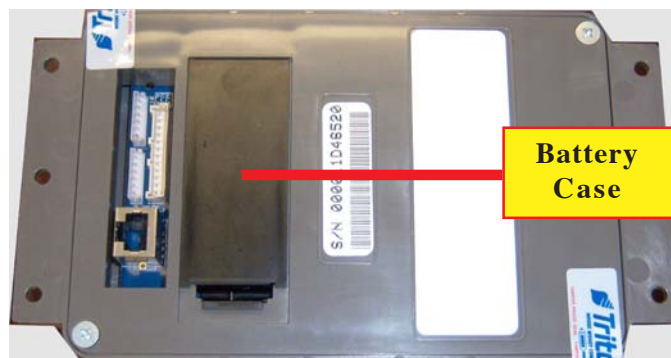

The spare battery for the T7 PCI-EPP may be purchased from Triton Systems:
P/N 01300-00023 (T7 PCI-EPP Lithium Battery)

THIS PAGE INTENTIONALLY LEFT BLANK

SUPPLEMENT B
TDM HARDWARE STATUS CODES
TDM CLICK COUNTS
TERMINAL ERROR CODES

MODEL RL5000 (X2) USER MANUAL

CLICK COUNTER HARDWARE STATUS CODES

The TDM-series click counter has new hardware status codes. The terminal will display and log Error Code **123**. It will then log the actual error in the click count. If there is a '116' in the click count, there will be a number immediately following that describes the error cause.

Ex: In the click history, you see '116', followed by '18'. This indicates a hardware error caused by the Extension Door Open.

Description	Status Code
Double detect (0) not connected	1
Width sensor (0) not connected (Tx)	2
Width sensor (0) not connected (Rx)	3
Double detect (1) not connected	4
Width sensor (1) not connected (Tx)	5
Width sensor (1) not connected (Rx)	6
Double detect (2) not connected	7
Width sensor (2) not connected (Tx)	8
Width sensor (2) not connected (Rx)	9
Double detect (3) not connected	0
Width sensor (3) not connected (Tx)	11
Width sensor (3) not connected (Rx)	12
Diverter sensor not connected	13
Timing wheel sensor not connected	14
Exit sensor not connected	15
Reject sensor not connected	16
Extension sensor not connected	17
Extension door open	18
Extension main cable disconnected	19
12-volt supply low	20
12-volt supply high	21
24-volt supply low	22
24-volt supply high	23
Missing pick motor feedback	24
Missing solenoid feedback	25
Pick motor fuse blown	26
Transport motor fuse blown	27

TERMINAL ERROR CODES

TDM CLICK COUNTERS

Click Count	Description
1	Non maskable interrupt - Terminal power shutdowns
2	Stack overflow
3	Stack underflow
4	Trap illbus
5	Trap illina
6	Trap illopa
7	Class B trap
8	Trap prtflt
9	Trap undopc
10	Trap unknown trap
11	CTS timeout
12	Tx Ack error
13	Tx Nak error
14	Tx EOT error
15	Tx response error - Main board
16	LRC error
17	Framing error
18	Overrun error
19	Parity error
20	Verify error - Main board
21	Process error
22	NVRAM read error
23	NVRAM write error
24	Reject rate exceeded - More than 9 notes rejected during a dispense
25	Unexpected note at thickness 0
26	Buffer overflow error
27	Host reset - Mechanism resets
28	Unexpected note at exit during a dispense
29	Width sensors detected note thinner than double-detect
30	Width sensors detected note thicker than double-detect
31	Width sensors disapproved note double-detect

MODEL RL5000 (X2) USER MANUAL

TDM CLICK COUNTERS

Click Count	Description
32	Width sensors thickness reading
33	Undefined
34	Pick motor timeout - Cassette "A"
35	Pick motor overcurrent - Cassette "A"
36	Thickness sensor unstable - Cassette "A"
37	Skew timeout - Cassette "A"
38	Thickness sensor timeout - Cassette "A"
39	Number of resets - Terminal power-up
40	Exit sensor timeout
41	Exit sensor trailing edge timeout
42	Diverter timeout
43	Reject sensor leading edge timeout
44	Reject sensor trailing edge timeout
45	Exit blocked during purge
46	Diverter timeout on purge
47	Width sensor blocked on start of dispense or learn
48	Exit sensor blocked on start of dispense or learn
49	Diverter in dispense position on start of dispense or learn
50	Reject cassette not present
51	Note cassette not present
52	Unexpected note at exit sensor
53	Unexpected note at width sensor
54	Diverter moved to exit position during reject or purge - Dispenser fault
55	Initial status check failed
56	Diverter moved to reject position during dispense - Dispenser fault
57	Unexpected note at reject sensor
58	Excessive skew on leading edge - Cassette "A"
59	Excessive skew on trailing edge - Cassette "A"
60	Note too wide - Cassette "A"
61	Note too narrow - Cassette "A"
62	Note too thick - Cassette "A"

TERMINAL ERROR CODES

TDM CLICK COUNTERS

Click Count	Description
63	Note too thin
64	Solenoid overcurrent
65	Timeout waiting for diverter - Diverter fault
66	Trailing edge timeout at width sensor - Cassette "A"
67	Watch dog reset
68	UART loop back failed
69	CRC flash check failed
70	CRC NVRAM check failed
71	Note not linear at trailing edge
72	Trailing edge timeout at thickness sensor
73	Oscillator WD
74	Forced reject - Will reject 2 notes (1 bad,1 good)
75	Timeout waiting for unexpected note to clear
76	Error in exit accountancy
77	Error in reject accountancy
78	A2D alignment error
79	Unable to clear width sensor during reject - After 9 attempts
80	Retried dispense operation
81	Retry event count
82	A2D Ch15A Comparator reference (2.5V)
83	A2D Ch.14A 24VDC (reading x 6)
84	A2D Ch.13 12VDC (reading x 3)
85	A2D Ch.12 Not used
86	A2D Ch.11 Low currency A (not used)
87	A2D Ch.10 Exit sensor voltage
88	A2D Ch.9 Reject sensor voltage
89	A2D Ch.8 Width sensor 2 voltage A
90	A2D Ch.7 Width sensor 1 voltage A
91	A2D Ch.6 Width sensor 0 voltage A
92	A2D Ch.5 (not used)
93	A2D Ch.4 Billfish extension fuse feedback

MODEL RL5000 (X2) USER MANUAL

TDM CLICK COUNTERS

Click Count	Description
94	A2D Ch.3 Main motor fuse feedback
95	A2D Ch.2 Double detect voltage A
96	A2D Ch.1 A Pick motor fuse
97	A2D Ch.0 Billfish extension feedback
98	Logic sensors diverter/dispenser position
99	A2D Ch.11 B (not used)
100	A2D Ch.8 B Width sensor 2 voltage B
101	A2D Ch.7 B Width sensor 1 voltage B
102	A2D Ch.6 B Width sensor 0 voltage B
103	A2D Ch.2 B Double detect B
104	A2D Ch.11 C (not used)
105	A2D Ch.8 C (not used)
106	A2D Ch.7 C (not used)
107	A2D Ch.6 C (not used)
108	A2D Ch.2 C (not used)
109	A2D Ch.11 D (not used)
110	A2D Ch.8 D (not used)
111	A2D Ch.7 D (not used)
112	A2D Ch.6 D (not used)
113	A2D Ch.2 D (not used)
114	Jam in Billfish
115	Motor fault - Main transport
116	Bad connection - Billfish door open, connectors, voltage
117	Cassettes shuffled - Cassette(s) not "In Service"
118	Trailing edge timeout at Billfish entrance
119	Billfish exit timeout
120	Billfish excessive skew
121	Trailing edge timeout at Billfish exit - Idler rollers "popped" out
122	Excessive skew on leading edge 1 - Note loading issue
123	Excessive skew on leading edge 2
124	Excessive skew on leading edge 3

TERMINAL ERROR CODES

TDM CLICK COUNTERS

Click Count	Description
125	Excessive skew on trailing edge 1
126	Excessive skew on trailing edge 2
127	Excessive skew on trailing edge 3
128	Note too wide 1
129	Note too wide 2
130	Note too wide 3
131	Note too narrow 1
132	Note too narrow 2
133	Note too narrow 3
134	Note too thick 1 - Cassette "B" (picked 2 notes)
135	Note too thick 2
136	Note too thick 3
137	Note too thin 1
138	Note too thin 2
139	Note too thin 3
140	Trailing edge timeout at thickness sensor 1
141	Trailing edge timeout at thickness sensor 2
142	Trailing edge timeout at thickness sensor 3
143	Trailing edge timeout at width sensor 1 - 2 notes picked
144	Trailing edge timeout at width sensor 2
145	Trailing edge timeout at width sensor 3
146	Pick motor timeout 1 - Cassette "B"
147	Pick motor timeout 2
148	Pick motor timeout 3
149	Pick motor overcurrent 1
150	Pick motor overcurrent 2
151	Pick motor overcurrent 3
152	Skew timeout 1 - Note skewed (width sensor)
153	Skew timeout 2
154	Skew timeout 3
155	Thickness sensor timeout 1 - Double detect fault

MODEL RL5000 (X2) USER MANUAL

TDM CLICK COUNTERS

Click Count	Description
156	Thickness sensor timeout 2
157	Thickness sensor timeout 3
158	Width sensor blocked on start of dispense or learn 1
159	Width sensor blocked on start of dispense or learn 2
160	Width sensor blocked on start of dispense or learn 3
161	Note cassette not present 1
162	Note cassette not present 2
163	Note cassette not present 3
164	Unexpected note at width sensor 1 - Cassette "B" (check cassette)
165	Unexpected note at width sensor 2
166	Unexpected note at width sensor 3
167	Note not linear at trailing edge 1
168	Note not linear at trailing edge 2
169	Note not linear at trailing edge 3
170	Timeout waiting for unexpected note to clear 1
171	Timeout waiting for unexpected note to clear 2
172	Timeout waiting for unexpected note to clear 3
173	Unable to clear width sensor during reject 1 - Cassette "B" (note jam)
174	Unable to clear width sensor during reject 2
175	Unable to clear width sensor during reject 3
176	Unexpected note at thickness 1 - Cassette "B"
177	Unexpected note at thickness 2
178	Unexpected note at thickness 3
179	Leading edge timeout at channel interface
180	Trailing edge timeout at channel interface
181	Excessive skew at channel interface
182	Timeout waiting for FIFO
183	Unexpected note in extension - enable "Extension Reject" option
184	Billfish motor fault - Timing wheel, jammed notes
185	Operation timeout
186	Billfish cable error - Feedback error (electronic loop)

TDM CLICK COUNTS / HARDWARE STATUS CODES / TERMINAL ERROR CODES

TDM CLICK COUNTERS

Click Count	Description
187	Learn error
188	FIFO error
189	Timeout waiting for notes to divert
190	Unable to open process
191	Billfish entrance volt A
192	Billfish entrance volt B
193	Billfish exit volt A
194	Billfish exit volt B
195	Skew board volt A
196	Skew board volt B
197	Width sensor gain
198	Unknown
199	Unknown
200	Average width A
201	Average width B
202	Average width C
203	Average width D
204	Average thickness A
205	Average thickness B
206	Average thickness C
207	Average thickness D
208	Too few double detect samples 0
209	Too few double detect samples 1
210	Too few double detect samples 2
211	Too few double detect samples 3

THIS PAGE INTENTIONALLY LEFT BLANK

TERMINAL ERROR CODES

Error Code	Description	Recommended Action
0	No errors	None
32	Good operation	No action required. The dispenser sends this status code when a command has been successfully executed. This status code will appear in the electronic journal as code 32 indicating the successful completion of a transaction.
33	Feed Failure	This error is usually associated with an empty note cassette or currency that is in "unfit" condition. 1. Refill the cassette as needed. 2. Inspect the cassette and feed path for currency that is stuck together or jammed. 3. If no jam is located, remove the first note from the cassette. Purge the dispenser. Do several test dispense operations. a. If the test dispenses are completed normally, and the return code are correct, clear all errors and place the cash dispenser in operation. b. If the test dispenser fails again, try testing while pushing in on the cassette. If it works then, the cassettes may not staying locked in the cassettes. Determine what is causing the cassette to not stay locked in place. 4. If the currency is in "fit" condition and the error persists, consider replacing the cassette or the dispenser.
33	Note jammed between DDM and Exit sensor	
34	Mis-tracked note at feed	This is a double detect fault. This is a double detect fault. 1. Inspect the feed path for jammed currency. Remove jammed currency. 2. Inspected both the feed sensor and the double detect sensor to ensure they are not blocked and operating correctly. Clean the sensors a needed. 3. Turn the AC power OFF for a few seconds and then back ON to power cycle and reset the cash dispenser. Clear all errors and perform several test dispenses. If the test dispenses are normal and the status clears, place the cash dispenser in service. If the error persists, replace the dispenser.
35	Mistracked note at double detect.	This status occurs when a note arrives at the double detect without being seen by the feed sensor. 1. Inspected both the feed sensor and the double detect sensor to ensure they are not blocked and operating correctly. Clean the sensors a needed. 2. Turn the AC power OFF for a few seconds and then back ON to power cycle and reset the cash dispenser. Clear all errors and perform several test dispenses. If the test dispenses are normal and the status clears, place the cash dispenser in service. If the error persists, replace the dispenser.
36	Mistracked note at exit.	This status occurs when a note is detected by the exit sensor when it should not have been. It can occur if there are notes already in the transport before the start of a transaction or if the exit sensor is blocked. 1. Verify that the diverter moves freely and is not binding. If the diverter has excessive binding or appears damaged, replace the dispenser. 2. Inspect the exit area to ensure nothing is blocking the exit sensor. Clean and verify the operation of the exit sensor. Replace the exit sensor if defective. Otherwise, replace the dispenser. 3. Turn the AC power OFF for a few seconds and then back ON to power cycle and reset the cash dispenser. Clear all errors and test the dispenser with a live transaction. If the status clears, place the cash dispenser in service. Otherwise, replace the dispenser.

37	Too long at exit.	<p>This status is reported if the exit sensor is covered for a longer than allowed time for the current notes.</p> <ol style="list-style-type: none"> 1. Inspect the note transport and delivery throat make sure all belts are on track and there are no documents jammed in the transport or exit areas. Place all belts on their respective rollers and gears. Clear the jammed documents. 2. Make sure that the exit sensor is clean and operation correctly. 3. Turn the AC power OFF for a few seconds and then back ON to power cycle and reset the cash dispenser. Clear all errors and test the dispenser with a live transaction. If the status clears, place the cash dispenser in service. Otherwise, replace the dispenser. <p>Note, if this occurs on a Mini Mech, only during a multi note dispense, the exit sensors may have become weak. Consider sending the dispenser to repair to have new sensors installed.</p>
38	Blocked exit	<p>This status appears if the exit sensor is covered or defective when the dispenser starts.</p> <ol style="list-style-type: none"> 1. Inspect the note transport make sure all belts are on track and there is no currency jammed in the transport or exit areas. Place all belts on their respective rollers and gears. Clear the jammed documents. 2. Make sure that the exit sensor is clean and operation correctly. 3. Turn the AC power OFF for a few seconds and then back ON to power cycle and reset the cash dispenser. Clear all errors and test the dispenser with a live transaction. If the status clears, place the cash dispenser in service. Otherwise, replace the dispenser.
39	Too many notes	<p>Clean the all sensors. Verify that all sensors are operation correctly. If all sensors are operation correctly, and the error persists, replace the replace the dispenser.</p>
42	Transport error.	<p>This is a timing wheel or timing wheel sensor error..</p> <ol style="list-style-type: none"> 1. Inspect the dispenser to make sure all belts are on track and in good physical condition. Place all belts on their rollers and gears. If a belt displays excessive wear or damage you may be able to replace it. Otherwise, replace the dispenser. 2. Verify that the DC voltages to the dispenser are correct. Replace the power supply or dispenser DC power if either is defective. 3. Examine the timing wheel for physical defect. Make sure the electrical connections to the timing wheel sensor are secure and the time wheel sensor is clean. Replace the timing wheel or the timing wheel sensors if they are defective. Otherwise, it may be necessary to replace the dispenser. 4. Turn the AC power OFF for a few seconds and then back ON to power cycle and reset the cash dispenser. Clear all errors and test the dispenser by completing several TEST DISPENSES. If the status clears and the return code are normal place the cash dispenser in service. If these actions have no effect, replace the dispenser.
44	Bad Roller Profile	<p>This status is generated if the double detect is unable to calibrate. Probable cause for this error is a faulty or uncalibrated double detect module, or a jammed currency in the double detect.</p> <ol style="list-style-type: none"> 1. Clear any jammed currency. 2. Turn the AC power OFF for a few seconds and then back ON to power cycle and reset the cash dispenser. Clear all errors and test the dispenser by completing several TEST DISPENSES. If the status clears and the return code are normal place the cash dispenser in service. If these actions have no effect, replace the dispenser.

45	Diverter error	This error occurs when the diverter is in the wrong position during a dispense. 1. Inspect the feed path for any jammed notes. Remove any jammed notes. 2. Turn the AC power OFF for a few seconds and then back on to power cycle and reset the cash dispenser. Clear the error. Purge the dispenser with the purge command. Complete several live dispenses to ensure the dispenser is working correctly. If the error persists, replace the dispenser.
46	Exit quantified	This status appears when the count at the exit is greater than the number of documents requested. 1. A mechanical error has occurred. It may be necessary to replace the dispenser.
47	Note missing at double detect	This status is generated if the double detect fails to detect a document already seen by the feed sensor. 1. Inspect the transport before the double detect for jammed currency. Clear the jammed currency. 2. Turn the AC power OFF for a few seconds and then back ON to power cycle and reset the cash dispenser. Clear all errors and test the dispenser by completing several TEST DISPENSES. If the status clears and the return code are normal place the cash dispenser in service. If these actions have no effect, replace the dispenser.
48	Reject rate exceeded.	This status is generated when there are 8 rejects during the current dispense. It is usually caused by attempting to dispense currency that is unacceptable or currency that has not been properly prepared. 1. Inspect the currency for excessive wear. Remove any unacceptable currency from the cassette. 2. Inspect the feed path for jammed currency. Remove any jammed currency. 3. Clear all error and purge the dispenser using the purge command. 4. Test the dispenser by completing several test dispenses with the test dispense command. If the error clears, put the cash dispenser back in service. If these actions have no effect, replace the dispensing mechanism.
49	Jam at exit	This status is generated when exit sensor is blocked. 1. Inspect the feed path for jammed currency. Remove any jammed currency. 2. Clear all error and purge the dispenser using the purge command. 3. Clean and verify the operation of the exit sensor. Replace the exit sensor if necessary. 4. Test the dispenser by completing several test dispenses with the test dispense command. If the error clears put the cash dispenser back in service. If these actions have no effect, replace the dispensing mechanism.
49	Too few notes dispensed Channel 1	
50	Interference recovery	Possible damage due to static discharge 1. Check the incoming power and dispenser mechanism for proper grounding. 2. Turn the AC power OFF for a few seconds and then back ON to power cycle and reset the cash dispenser. 3. Clear all errors and test the dispenser by completing several test dispenses. If the status clears and the return code are normal place the cash dispenser in service. If these actions have no effect, replace the dispenser.
51	Accountancy error	A mechanical failure has occurred. Replace the dispensing mechanism.
52	RAM error	A mechanical failure has occurred. Replace the dispensing mechanism.
53	EPROM error	A mechanical failure has occurred. Replace the dispensing mechanism.

		mechanism.
54	Operation time-out	<ol style="list-style-type: none"> 1. Check the incoming power and dispenser mechanism for proper grounding. 2. Turn the AC power OFF for a few seconds and then back ON to power cycle and reset the cash dispenser. 3. Clear all errors and test the dispenser by completing several test dispenses. If the status clears and the return code are normal place the cash dispenser in service. If these actions have no effect, replace the dispenser
55	RAM corruption	A mechanical failure has occurred. Replace the dispensing mechanism.
56	Link error	<ol style="list-style-type: none"> 1. Configuration jumpers may have been changed. Inspect jumper block LK5 on the dispenser main board. There should be no jumpers installed. 2. Turn the AC power OFF for a few seconds and then back ON to power cycle and reset the cash dispenser. 3. If the problem persists, replace the dispensing mechanism
76	Communications error with EJ	
95	Multiple cassettes of the same type installed	This is a multi-cassette dispenser error. <ol style="list-style-type: none"> 1. Verify that there is only one of each type of cassette installed in the dispensing mechanism. 2. If two or more of the same type cassette are installed, inject a new cassette ID into one of the cassettes that is different from the other cassette.
100	Good operation	No Action Necessary. The dispenser sends this status code when a command has been successfully executed. This status code will appear in the electronic journal as code 32 or 100 indicating the successful completion of a transaction.
101	2-second timeout waiting for pick. (Feed failure).	<p>This error is usually associated with ""unfit"" currency or an empty cassette.</p> <ol style="list-style-type: none"> 1. Refill the cassette as needed. 2. Inspect the feed path for currency that is stuck together or jammed. If no jams are found, remove the note closest the pick rollers in the cassette. 3. Inspect the detent clips (the clips that hold the cassette in place). Cracked or broken clips should be replaced 4. Install the cassette. Purge the dispensing mechanism with the PURGE command from the DIAGNOSTICS function. Test the TDM-100 by completing several Test Dispenses. If the error clears, put the cash dispenser in service. 5. If the currency is in ""fit"" condition and the error condition persists, consider replacing the note cassette or the dispensing mechanism. <p>Note: Dispenser Status (Click Counts) should be run and available before contacting Tech Support</p>
102	Timeout at Exit Sensor	<ol style="list-style-type: none"> 1. Inspect for jammed currency in the feed path and at the Exit sensor. Remove any jammed currency. 2. Purge the dispenser using the purge command. Test the dispensing mechanism by completing several Test Dispenses. 3. If the error clears put the Cash Dispenser into service. Otherwise, replace the dispensing mechanism. <p>Note: Dispenser Status (Click Counts) should be run and available before contacting Tech Support</p>

104	Unable to clear width sensor.	Remove the cassette and inspect for jammed currency in the width sensor and at the output of the cassette. The width sensor may be dirty. Clean the width sensor with compressed air. Purge the dispenser using the purge command. Test the dispensing mechanism by completing several test dispenses. If the error does not occur again, put the cash dispenser in service. If the error persists in may be necessary to replace either the cassette or dispensing mechanism. Note: Dispenser Status (Click Counts) should be run and available before contacting Tech Support
105	Insufficient notes to learn from	There may be an insufficient number of notes in the cassette to complete the requested "learn note thickness" command. Put more currency in the cassette and repeat the "learn note thickness" command. Note: Dispenser Status (Click Counts) should be run and available before contacting Tech Support
106	FIFO error	The dispensing mechanism may have corrupt software. Reset the cash dispenser. Purge the dispenser using the purge command. Test the dispensing mechanism by completing several test dispenses. If the error clears put the cash dispenser into service. If the error persists, replace the dispensing mechanism. Note: Dispenser Status (Click Counts) should be run and available before contacting Tech Support
107	Time out waiting for FIFO	
108	Unexpected note at double detect, width sensor did not detect note	A note has been detected in the double detect sensor without being detected at the width sensor first. 1. Inspect the dispensing mechanism for of damaged components or broken wires. 2. Remove the cassette and visually inspect for loose or disconnected connectors on both the upper and lower width sensor printed circuit boards. 3. Ensure the ATM is mounted on a hard steady surface. Vibrations can cause this error. 4. If there is no visible damage and the connectors are attached to the sensor boards the best course of action is to replace the dispensing mechanism. Note: Dispenser Status (Click Counts) should be run and available before contacting Tech Support
109	Time-out at Exit sensor	1. Inspect for jammed currency in the feed path and at the Exit sensor. Remove any jammed currency. 2. Purge the dispenser using the purge command. Test the dispensing mechanism by completing several Test Dispenses. 3. If the error clears put the Cash Dispenser into service. Otherwise, replace the dispensing mechanism. Note: Dispenser Status (Click Counts) should be run and available before contacting Tech Support
110	Trailing edge time-out at exit.	1. Inspect for jammed Currency in the feed path and at the Exit sensor. Remove any jammed currency. 2. Purge the dispenser using the purge command. 3. Test the dispensing mechanism by completing several test dispenses. 4. If the error clears put the cash dispenser into service. If the error persists, replace the dispensing mechanism. Note: Dispenser Status (Click Counts) should be run and available before contacting Tech Support

111	Diverter timeout	<p>Inspect for jammed currency at the diverter. Remove jammed currency.</p> <p>2. Verify that all access panels are closed and secured. Clear the error. Test the dispenser by completing several test dispenses.</p> <p>3. If the error clears, put the cash dispenser in service.</p> <p>4. Verify clearance at the diverter. If the test dispenses pass, but the error returns upon live dispenses, do dispenses with the vault door open. If it works with the door open, remove obstruction causing the diverter to contact the vault door.</p> <p>5. If these actions have no effect on dispenser operation, replace the dispenser mechanism.</p> <p>Note: Dispenser Status (Click Counts) should be run and available before contacting Tech Support</p>
112	Timeout waiting for leading edge at reject	<p>A note that was expected to be seen at reject sensor was not detected at the reject sensor.</p> <p>1. Inspect for jammed currency in the transport path between the width sensors and the reject sensor. Remove jammed currency.</p> <p>2. Verify that all access panels are closed and secured. Clear the error. Test the dispenser by completing several test dispenses.</p> <p>3. Verify clearance at the diverter. If the test dispenses pass, but the error returns upon live dispenses, do dispenses with the vault door open. If it works with the door open, remove obstruction causing the diverter to contact the vault door.</p> <p>4. If the error clears, put the cash dispenser in service.</p> <p>5. If these actions have no effect on dispenser operation, replace the dispenser mechanism.</p> <p>Note: Dispenser Status (Click Counts) should be run and available before contacting Tech Support</p>
113	Timeout waiting for trailing edge at reject	<p>1. Inspect for a jammed currency in the reject sensor.</p> <p>2. Verify that all access panels are closed and secured. Ensure the reject bin is empty, or that there is enough room for the rejects and test notes to fall into the reject bin. Reset the cash dispenser. Clear the error. Test the dispenser by completing several test dispenses.</p> <p>3. If the error clears, put the cash dispenser in service.</p> <p>4. If these actions have no effect on dispenser operation, replace the dispenser mechanism.</p> <p>Note: Dispenser Status (Click Counts) should be run and available before contacting Tech Support</p>
114	Exit blocked during purge	<p>1. Inspect the dispensing mechanism for jammed currency at the exit sensor. Clear any jammed currency.</p> <p>2. Clean the exit sensor using a soft brush and a vacuum cleaner. Reset the cash dispenser. Clear the error.</p> <p>3. Test the dispenser by completing several test dispenses.</p> <p>4. If the error clears, put the cash dispenser in service.</p> <p>5. If these actions have no effect on dispenser operation, replace the dispenser mechanism.</p> <p>Note: Dispenser Status (Click Counts) should be run and available before contacting Tech Support</p>
115	Diverter timeout on purge	<p>1. Inspect the dispensing mechanism for jammed currency at the diverter. Clear any jammed currency.</p> <p>2. Make sure the shelf that the dispenser is mounted on is level and seated at all four corners.</p> <p>3. Make sure the diverter moves freely.</p> <p>4. Reset the cash dispenser. Clear the error.</p> <p>5. Test the dispenser by completing several test dispenses. If the error clears, put the cash dispenser in service.</p> <p>6. If these actions have no effect on dispenser operation, replace the dispenser mechanism.</p> <p>Note: Dispenser Status (Click Counts) should be run and available before contacting Tech Support</p>

116	Motor Fault	<ol style="list-style-type: none"> 1. Inspect for jammed currency in the feed path and at the Exit sensor. Remove any jammed currency. 2. Purge the dispenser using the purge command. Test the dispensing mechanism by completing several Test Dispenses. 3. If the error clears put the Cash Dispenser into service. Otherwise, replace the dispensing mechanism. <p>Note: Dispenser Status (Click Counts) should be run and available before contacting Tech Support</p>
117	Timeout waiting for note to divert	
118	Exit sensor blocked on start of dispense or learn	<ol style="list-style-type: none"> 1. Inspect for jammed currency at the Exit. Remove jammed currency. 2. Verify that all access panels are closed and secured. 3. Use a soft brush and vacuum cleaner to clean the exit sensor. 4. Clear the error. Test the dispenser by completing several test dispenses. 5. If the error clears, put the cash dispenser in service. 6. If these actions have no effect on dispenser operation, replace the dispenser mechanism. <p>Note: Dispenser Status (Click Counts) should be run and available before contacting Tech Support</p>
119	Diverter in dispense position on start of dispense or learn	<ol style="list-style-type: none"> 1. Inspect for jammed currency at the Diverter. Remove jammed currency. 2. Check the operation of the diverter solenoid. 3. Verify that all access panels are closed and secured. Clear the error. Test the dispenser by completing several test dispenses. 4. If the error clears, put the cash dispenser in service. 5. If these actions have no effect on dispenser operation, replace the dispenser mechanism. <p>Note: Dispenser Status (Click Counts) should be run and available before contacting Tech Support</p>
121	Note cassette not present	
122	Unexpected note at exit	<ol style="list-style-type: none"> 1. Purge the dispenser using the purge command from diagnostic menu. 2. Test the dispenser by completing several test dispenses. If the error clears, put the cash dispenser in service. 3. If these actions have no effect on dispenser operation, replace the dispenser mechanism and/or the note cassette. <p>Note: Dispenser Status (Click Counts) should be run and available before contacting Tech Support</p>
123	Hardware Error	<ol style="list-style-type: none"> 1. Purge the dispenser using the purge command from diagnostic menu. 2. Test the dispenser by completing several test dispenses. If the error clears, put the cash dispenser in service. 3. If these actions have no effect on dispenser operation, print a dispenser status report, scan the click count history, starting at the bottom. Find the first occurrence of "116". The next entry, below 116 is the Hardware Status. Look up the definition on the Hardware Status listing. 4. If problems still persist, replace the dispenser mechanism and/or the note cassette. <p>Note: Dispenser Status (Click Counts) should be run and available before contacting Tech Support</p>
124	Diverter moved to exit position during reject purge	<ol style="list-style-type: none"> 1. Inspect for a currency jam at the diverter. 2. Verify that the diverter moves freely. 3. Test the dispenser by completing several test dispenses. 4. If the error clears, put the cash dispenser in service. 5. If these actions have no effect on dispenser operation, replace the dispenser mechanism. <p>Note: Dispenser Status (Click Counts) should be run and available before contacting Tech Support</p>

125	Initial status check failed	<ol style="list-style-type: none"> 1. Reset the cash dispenser. Clear the error. 2. If the error persists replace the dispensing mechanism. <p>Note: Dispenser Status (Click Counts) should be run and available before contacting Tech Support</p>
126	Diverter moved to reject position during dispense	<p>Inspect for a note jam at the diverter. Verify that the diverter moves freely. Test the dispenser by completing several test dispenses. If the error clears, put the cash dispenser in service. If these actions have no effect on dispenser operation, replace the dispenser mechanism. Note: Dispenser Status (Click Counts) should be run and available before contacting Tech Support</p>
127	Jam in TDM extension	<ol style="list-style-type: none"> 1. Inspect for a currency jam at in the extension. 2. Test the dispenser by completing several test dispenses. 3. If the error clears, put the cash dispenser in service. 4. If these actions have no effect on dispenser operation, replace the dispenser mechanism. <p>Note: Dispenser Status (Click Counts) should be run and available before contacting Tech Support</p>
128	Error in reply from the dispenser mechanism	<ol style="list-style-type: none"> 1. Verify that the power supply is operating and the DC voltages being supplied to the main board and dispenser are correct. Seat connectors or replace the power supply as needed. 2. Verify that main board to electronic journal and the electronic journal to dispenser cables securely seated at both ends of the cable. The cables may be defective. 3. Other components that may cause this error are the main board or the dispensing mechanism.
129	No response from the dispenser mechanism	<ol style="list-style-type: none"> 1. Verify that the power supply is operating and the DC voltages being supplied to the main board and dispenser are correct. Seat connectors or replace the power supply as needed. 2. Verify that main board to electronic journal and the electronic journal to dispenser cables securely seated at both ends of the cable. The cables may be defective. 3. Other components that may cause this error are the main board or the dispensing mechanism.
130	Command not acknowledged by the dispenser mechanism	<ol style="list-style-type: none"> 1. Verify that the power supply is operating and the DC voltages being supplied to the main board and dispenser are correct. Seat connectors or replace the power supply as needed. 2. Verify that main board to electronic journal and the electronic journal to dispenser cables securely seated at both ends of the cable. The cables may be defective. 3. Other components that may cause this error are the main board or the dispensing mechanism.
131	CTS (Clear To Send) line from the dispenser is not active.	<ol style="list-style-type: none"> 1. Verify that the power supply is operating and the DC voltages being supplied to the main board and dispenser are correct. Seat connectors or replace the power supply as needed. 2. Verify that main board to electronic journal and the electronic journal to dispenser cables securely seated at both ends of the cable. The cables may be defective. 3. Other components that may cause this error are the main board or the dispensing mechanism.
132	Status reports bad double detect in last dispense	<ol style="list-style-type: none"> 1. Remove the cassette and inspect the dispenser's feed path for jammed currency and other debris in the double detect assembly. Replace the cassette. 2. Reset the Cash Dispenser by turning OFF the AC power switch for a few seconds and switching it back ON. Clear the error. Purge the dispenser using PURGE command. Complete several Test Dispenses to verify correct operation. 3. If the problem persists, replace the dispensing mechanism.

133	+5 VDC not present on carrier detect	1. Verify that the power supply is operating and the DC voltages being supplied to the main board and dispenser are correct. Seat connectors or replace the power supply as needed. 2. Verify that main board to electronic journal and the electronic journal to dispenser cables securely seated at both ends of the cable. The cables may be defective. 3. Other components that may cause this error are the main board or the dispensing mechanism.
134	Exit blocked as reported by status check	1. Inspect the feed path and exit sensor for jammed currency and broken components. The exit sensor may be dirty. Clean as needed with soft brush and vacuum cleaner. 2. Reset the cash dispenser by turning OFF the AC power switch for a few seconds and switching it back ON. Clear the error. Purge the dispenser with the purge command. Verify correct operation with a live transaction. 3. If the problem persists, replace the dispensing mechanism.
135	Feed sensor blocked as reported by status check	1. Inspect the feed path and Feed sensors for jammed currency and broken components. The feed sensors may be dirty. Clean as needed with soft brush and vacuum cleaner. 2. Reset the Cash Dispenser by turning OFF the AC power switch for a few seconds and switching it back ON. Clear the error. Purge the dispenser with the purge command. 3. Complete several test dispenses to verify correct operation. If the problem persists, replace the dispensing mechanism.
136	Modem initialization failed	1. Reset the Cash Dispenser by turning OFF the AC power switch for a few seconds and switching it back ON. 2. If the problem persists, remove the main board and replace the modem. 3. If replacing the modem does not correct the problem, replace the main board.
138	Printer failed while printing to the receipt printer	1. Verify that there is paper in the printer. Replenish paper as needed. Refer to Section 5 of the RL5000 Service Manual or the RL5000 Quick Reference Guide for instructions. 2. Release the printer locking screw. Open the printer support bracket and verify that there are no jams in the printer or the paper path. Verify the blue lever on the left side of the printer in the print position. 3. Inspect the cable supplying DC power from the power supply to the printer. Make sure it is connected to CN1 on the printer control board. Verify that all DC voltages applied to the printer control board are correct. If the voltages are not within tolerance, the cable or power supply may be defective. 4. Inspect the printer data cable for damage. Make sure it is seated at the main board and at the printer control board at CN6. 5. Inspect the cables connected to CN2, CN3, CN4, and CN5. Make sure they are seated at the printer control board and not damaged. 6. If the voltages are correct, and the cables are undamaged and correctly connected, causes of this error may be a defective cable, a defective printer, printer control board, or the main board.

139	Printer controller not responding to commands	<p>1. Verify that there is paper in the printer. Replenish paper as needed. Refer to the appropriate Service Manual or Quick Reference Guide for instructions.</p> <p>2. On all models other than 96XX, Release the printer locking screw. Open the printer support bracket and verify that there are no jams in the printer or the paper path. Verify the blue lever on the left side of the printer in the print position.</p> <p>3. Inspect the cable supplying DC power from the power supply to the printer. Make sure it is connected to CN1 on the printer control board. Verify that all DC voltages applied to the printer control board are correct. If the voltages are not within tolerance, the cable or power supply may be defective.</p> <p>4. Inspect the printer data cable for damage. Make sure it is seated at the main board and at the printer control board at CN6.</p> <p>5. Inspect the cables connected to CN2, CN3, CN4, and CN5. Make sure they are seated at the printer control board and not damaged.</p> <p>6. If the voltages are correct, and the cables are undamaged and correctly connected, causes of this error may be a defective cable, a defective printer, printer control board, or the main board.</p> <p>7. On 96XX models, open the printer access latch and inspect for jams and blockage.</p> <p>8. . Inspect the cable supplying DC power from the power supply to the printer. Make sure it is connected to CN1 on the printer control board. Verify that all DC voltages applied to the printer control board are correct. If the voltages are not within tolerance, the cable or power supply may be defective.</p> <p>9. Verify all connections to the printer controller.</p> <p>10. Inspect the printer data cable for damage. Make sure it is seated at both the printer controller and the keypad - SPED board - Visa EPP jumper board.</p> <p>11. If the voltages are correct, and the cables are undamaged and correctly connected, causes of this error may be a defective cable, a defective printer, printer control board, or the main board.</p>
140	Time-out waiting for printer to be ready	<p>1. Verify that there is paper in the printer. Replenish paper as needed. Refer to Section 5 of the RL5000 Service Manual or the RL5000 Quick Reference Guide for instructions.</p> <p>2. Release the printer locking screw. Open the printer support bracket and verify that there are no jams in the printer or the paper path. Verify the blue lever on the left side of the printer in the print position.</p> <p>3. Inspect the cable supplying DC power from the power supply to the printer. Make sure it is connected to CN1 on the printer control board. Verify that all DC voltages applied to the printer control board are correct. If the voltages are not within tolerance, the cable or power supply may be defective.</p> <p>4. Inspect the printer data cable for damage. Make sure it is seated at the main board and at the printer control board at CN6.</p> <p>5. Inspect the cables connected to CN2, CN3, CN4, and CN5. Make sure they are seated at the printer control board and not damaged.</p> <p>6. If the voltages are correct, and the cables are undamaged and correctly connected, causes of this error may be a defective cable, a defective printer, printer control board, or the main board.</p>
141	Paper jam reported by the controller during status check.	<p>1. Release the printer locking screw. Open the printer support bracket and verify that there are no jams in the printer or the paper path. Verify the blue lever on the left side of the printer in the print position.</p> <p>2. Release the printer locking screw. Open the printer support bracket and verify that there are no jams in the printer or the paper path. Verify the blue lever on the left side of the printer in the print position.</p> <p>3. Inspect the cable supplying DC power from the power supply to the printer. Make sure it is connected to CN1 on the printer control board. Verify that all DC voltages applied to the printer control board are correct. If the voltages are not within tolerance, the cable or power supply may be defective.</p> <p>4. Inspect the printer data cable for damage. Make sure it is seated at the main board and at the printer control board at CN6.</p> <p>5. Inspect the cables connected to CN2, CN3, CN4, and CN5. Make sure they are seated at the printer control board and not damaged.</p>

		6. If the voltages are correct, and the cables are undamaged and correctly connected, causes of this error may be a defective cable, a defective printer, printer control board, or the main board.
142	Dispenser returns bad command error.	1. Verify that the power supply is operating and the DC voltages being supplied to the main board and dispenser are correct. Seat connectors or replace the power supply as needed. 2. Verify that main board to electronic journal and the electronic journal to dispenser cables securely seated at both ends of the cable. The cables may be defective. 3. Other components that may cause this error are the main board or the dispensing mechanism.
144	No reply from the electronic journal.	1. Inspect main board to electronic journal (EJ) communication cable for damage. Make sure the connectors are seated securely on the main board and on the electronic journal. a. When troubleshooting the 8100, 9100, RL and RT be aware that the electronic journal is built into the main board of the dispenser. b. On all 8100/9100 machines, ensure the EJ data cable is connected to the lower RJ-45 data port on the 9100 main board. The upper RJ-45 port is used for downloading software only. Note, if the EJ is connected to the load port of the 9100 main board, permanent damage may result. 2. If it is necessary to check continuity of the cable assembly, refer to the appropriate ATM Service Manual for pin out of the cable assembly. 3. Inspect electronic journal to dispenser communication cable for damage. Make sure the connectors are seated securely on the main board and on the electronic journal. 4. If it is necessary to check continuity of the cable assembly, refer to the appropriate ATM Service Manual for pin out of the cable assembly 5. If the cables are undamaged, the main board or electronic journal may be defective.
145	Error in reply from the electronic journal	1. Inspect main board to electronic journal communication cable for damage. Make sure the connectors are seated securely on the main board and on the electronic journal. 2. If it is necessary to check continuity of the cable assembly, refer to the appropriate ATM Service Manual for pin out of the cable assembly. 3. Inspect electronic journal to dispenser communication cable for damage. Make sure the connectors are seated securely on the main board and on the electronic journal. 4. If it is necessary to check continuity of the cable assembly, refer to the appropriate ATM Service Manual for pin out of the cable assembly 5. If the cables are undamaged, the main board or electronic journal may be defective.

146	No reply from command to electronic journal	<ol style="list-style-type: none"> 1. Inspect main board to electronic journal communication cable for damage. Make sure the connectors are seated securely on the main board and on the electronic journal. 2. If it is necessary to check continuity of the cable assembly, refer to the appropriate ATM Service Manual for pin out of the cable assembly. 3. Inspect electronic journal to dispenser communication cable for damage. Make sure the connectors are seated securely on the main board and on the electronic journal. 4. If it is necessary to check continuity of the cable assembly, refer to the appropriate ATM Service Manual for pin out of the cable assembly 5. If the cables are undamaged, the main board or electronic journal may be defective.
147	Error in reply from electronic journal.	<ol style="list-style-type: none"> 1. Inspect main board to electronic journal communication cable for damage. Make sure the connectors are seated securely on the main board and on the electronic journal. 2. If it is necessary to check continuity of the cable assembly, refer to the appropriate ATM Service Manual for pin out of the cable assembly. 3. Inspect electronic journal to dispenser communication cable for damage. Make sure the connectors are seated securely on the main board and on the electronic journal. 4. If it is necessary to check continuity of the cable assembly, refer to the appropriate ATM Service Manual for pin out of the cable assembly. 5. If the cables are undamaged, the main board or electronic journal may be defective.
148	Write to electronic journal failed	<p>Most probable cause, the electronic journal is full. State by verify if this is associated with error code 151. If so, work to resolve error code 151.</p> <ol style="list-style-type: none"> 1. Inspect main board to electronic journal communication cable for damage. Make sure the connectors are seated securely on the main board and on the electronic journal. 2. If it is necessary to check continuity of the cable assembly, refer to the appropriate ATM Service Manual for pin out of the cable assembly. 3. Inspect electronic journal to dispenser communication cable for damage. Make sure the connectors are seated securely on the main board and on the electronic journal. 4. If it is necessary to check continuity of the cable assembly, refer to the appropriate ATM Service Manual for pin out of the cable assembly 5. If the cables are undamaged, the main board or electronic journal may be defective.
149	Read from electronic journal failed	<ol style="list-style-type: none"> 1. Inspect main board to electronic journal communication cable for damage. Make sure the connectors are seated securely on the main board and on the electronic journal. 2. If it is necessary to check continuity of the cable assembly, refer to the appropriate ATM Service Manual for pin out of the cable assembly. 3. Inspect electronic journal to dispenser communication cable for damage. Make sure the connectors are seated securely on the main board and on the electronic journal. 4. If it is necessary to check continuity of the cable assembly, refer to the appropriate ATM Service Manual for pin out of the cable assembly 5. If the cables are undamaged, the main board or electronic journal may be defective.

150	Status command to journal failed	<ol style="list-style-type: none"> 1. Inspect main board to electronic journal communication cable for damage. Make sure the connectors are seated securely on the main board and on the electronic journal. 2. If it is necessary to check continuity of the cable assembly, refer to the appropriate ATM Service Manual for pin out of the cable assembly. 3. Inspect electronic journal to dispenser communication cable for damage. Make sure the connectors are seated securely on the main board and on the electronic journal. 4. If it is necessary to check continuity of the cable assembly, refer to the appropriate ATM Service Manual for pin out of the cable assembly 5. If the cables are undamaged, the main board or electronic journal may be defective.
151	Electronic journal full	<p>The electronic journal on 8-bit machines (9600, 9700, and 9100) can store as many as 2400 records. The journal on these machines should be printed on a regular basis (i.e. when completing a cassette close function.) to keep it from filling up. If the journal becomes, full the only way it can be cleared and have a copy of it records is to print to the receipt printer or download the journal to the Triton Connect host. On 32-bit machines (RL's, FT's, RT's) the electronic journal can store as many as 32,768 records, it is recommended that you do not print the journal. Instead, save the journal to an external USB storage device or download to Triton Connect. Once records have been viewed or saved, they need to be marked as audited. Audited records can then be archived to an external device or deleted. (Note: Records can be archived to the internal flash. Doing this will not clear any available memory, and will not aid in clearing Error Code 151.) Below are steps to take to clear Error code 151 on 32-bit machines:</p> <ol style="list-style-type: none"> 1. View Unaudited Records. Once they are displayed on the screen, print or save them to an external device. When done chose, marked as audited. 2. Download to Triton Connect. Ensure they are marked as audited. 3. Choose Clear Journal. Once you have completed one of the above steps, the records have been marked as audited, but they are still taking up memory space. They now need to be deleted or archived to an external USB Storage device. 4. Select Archive / Delete Journal. 5. Choose archive to external USB storage device or delete. Choosing Internal Flash will not aid in clearing Error Code 151. <p>Warning: If delete is chosen, the records will be permanently deleted. Note: Turning on auto archive will eliminate the need to archive the records in the future. The recommended setting for Auto Archive is None / 1 Meg / 14 days. Keep in mind that no files will be deleted or archived until they have been audited.</p>
152	Electronic journal corrupt	<ol style="list-style-type: none"> 1. Inspect main board to electronic journal communication cable for damage. Make sure the connectors are seated securely on the main board and on the electronic journal. 2. If it is necessary to check continuity of the cable assembly, refer to Appendix B for pin out of the cable assembly. 3. Inspect electronic journal to dispenser communication cable for damage. Make sure the connectors are seated securely on the main board and on the electronic journal. 4. If it is necessary to check continuity of the cable assembly, refer to the appropriate ATM Service Manual for pin out of the cable assembly 5. If the cables are undamaged, the main board or electronic journal may be defective.

153	Electronic journal mode	<ol style="list-style-type: none"> 1. Inspect main board to electronic journal communication cable for damage. Make sure the connectors are seated securely on the main board and on the electronic journal. 2. If it is necessary to check continuity of the cable assembly, refer to Appendix B for pin out of the cable assembly. 3. Inspect electronic journal to dispenser communication cable for damage. Make sure the connectors are seated securely on the main board and on the electronic journal. 4. If it is necessary to check continuity of the cable assembly, refer to Appendix B for pin out of the cable assembly 5. If the cables are undamaged, the main board or electronic journal may be defective.
154	Unknown electronic journal status	<ol style="list-style-type: none"> 1. Inspect main board to electronic journal communication cable for damage. Make sure the connectors are seated securely on the main board and on the electronic journal. 2. If it is necessary to check continuity of the cable assembly, refer to the appropriate ATM Service Manual for pin out of the cable assembly. 3. Inspect electronic journal to dispenser communication cable for damage. Make sure the connectors are seated securely on the main board and on the electronic journal. 4. If it is necessary to check continuity of the cable assembly, refer to the appropriate ATM Service Manual for pin out of the cable assembly 5. If the cables are undamaged, the main board or electronic journal may be defective.
155	Electronic journal modify record failure	<ol style="list-style-type: none"> 1. Inspect main board to electronic journal communication cable for damage. Make sure the connectors are seated securely on the main board and on the electronic journal. 2. If it is necessary to check continuity of the cable assembly, refer to Appendix B for pin out of the cable assembly. 3. Inspect electronic journal to dispenser communication cable for damage. Make sure the connectors are seated securely on the main board and on the electronic journal. 4. If it is necessary to check continuity of the cable assembly, refer to Appendix B for pin out of the cable assembly 5. If the cables are undamaged, the main board or electronic journal may be defective.
156	Cassette out of service.	<p>This occurs when the last cassette has been taken out of service. Cassettes are taken out of service because of feed failures or excessive rejects.</p> <ol style="list-style-type: none"> 1. Inspect cassettes. Fill if needed. If they are not empty, see corrective action for Error Code 33. 2. If excessive rejects are suspected, see corrective action for Error Code 48. 3. Place cassettes in service.
157	Erase command to electronic journal failed	<ol style="list-style-type: none"> 1. Inspect main board to electronic journal communication cable for damage. Make sure the connectors are seated securely on the main board and on the electronic journal. 2. If it is necessary to check continuity of the cable assembly, refer to the appropriate ATM Service Manual for pin out of the cable assembly. 3. Inspect electronic journal to dispenser communication cable for damage. Make sure the connectors are seated securely on the main board and on the electronic journal. 4. If it is necessary to check continuity of the cable assembly, refer to the appropriate ATM Service Manual for pin out of the cable assembly 5. If the cables are undamaged, the main board or electronic journal may be defective.

158	Format command to electronic journal failed	<ol style="list-style-type: none"> 1. Inspect main board to electronic journal communication cable for damage. Make sure the connectors are seated securely on the main board and on the electronic journal. 2. If it is necessary to check continuity of the cable assembly, refer to the appropriate ATM Service Manual for pin out of the cable assembly. 3. Inspect electronic journal to dispenser communication cable for damage. Make sure the connectors are seated securely on the main board and on the electronic journal. 4. If it is necessary to check continuity of the cable assembly, refer to the appropriate ATM Service Manual for pin out of the cable assembly 5. If the cables are undamaged, the main board or electronic journal may be defective.
159	Electronic journal test feature failed	<ol style="list-style-type: none"> 1. Inspect main board to electronic journal communication cable for damage. Make sure the connectors are seated securely on the main board and on the electronic journal. 2. If it is necessary to check continuity of the cable assembly, refer to the appropriate ATM Service Manual for pin out of the cable assembly. 3. Inspect electronic journal to dispenser communication cable for damage. Make sure the connectors are seated securely on the main board and on the electronic journal. 4. If it is necessary to check continuity of the cable assembly, refer to the appropriate ATM Service Manual for pin out of the cable assembly 5. If the cables are undamaged, the main board or electronic journal may be defective.
160	Electronic journal set featured failed	<ol style="list-style-type: none"> 1. Inspect main board to electronic journal communication cable for damage. Make sure the connectors are seated securely on the main board and on the electronic journal. 2. If it is necessary to check continuity of the cable assembly, refer to Appendix B for pin out of the cable assembly. 3. Inspect electronic journal to dispenser communication cable for damage. Make sure the connectors are seated securely on the main board and on the electronic journal. 4. If it is necessary to check continuity of the cable assembly, refer to the appropriate ATM Service Manual for pin out of the cable assembly 5. If the cables are undamaged, the main board or electronic journal may be defective.
161	Electronic journal clear feature failed	<ol style="list-style-type: none"> 1. Inspect main board to electronic journal communication cable for damage. Make sure the connectors are seated securely on the main board and on the electronic journal. 2. If it is necessary to check continuity of the cable assembly, refer to the appropriate ATM Service Manual for pin out of the cable assembly. 3. Inspect electronic journal to dispenser communication cable for damage. Make sure the connectors are seated securely on the main board and on the electronic journal. 4. If it is necessary to check continuity of the cable assembly, refer to the appropriate ATM Service Manual for pin out of the cable assembly 5. If the cables are undamaged, the main board or electronic journal may be defective.

162	Electronic Journal get serial number failed	<ol style="list-style-type: none"> 1. Inspect main board to electronic journal communication cable for damage. Make sure the connectors are seated securely on the main board and on the electronic journal. 2. If it is necessary to check continuity of the cable assembly, refer to the appropriate ATM Service Manual for pin out of the cable assembly. 3. Inspect electronic journal to dispenser communication cable for damage. Make sure the connectors are seated securely on the main board and on the electronic journal. 4. If it is necessary to check continuity of the cable assembly, refer to the appropriate ATM Service Manual for pin out of the cable assembly 5. If the cables are undamaged, the main board or electronic journal may be defective.
163	Terminal did not answer. This is a Triton Connect error.	<ol style="list-style-type: none"> 1. This error is not displayed at the cash dispenser. The Triton Connect Host Computer generates the error when the terminal does not respond to a telephone call from the Triton Connect Host Computer. 2. The cash dispenser may be turned OFF, the modem may be defective, or the telephone line may be shared with another device that connects to the line before the cash dispenser. Additionally, the Triton Connect feature may be disabled at the Cash Dispenser.
164	Terminal did not return call. Triton Connect error.	This error is not displayed at the Cash Dispenser. The Triton Connect Host Computer generates this error when a terminal does not return a call to the Triton Connect Host Computer as requested. The modem may be defective.
165	Electronic journal not present	<ol style="list-style-type: none"> 1. Inspect main board to electronic journal communication cable for damage. Make sure the connectors are seated securely on the main board and on the electronic journal. 2. If it is necessary to check continuity of the cable assembly, refer to the appropriate ATM Service Manual for pin out of the cable assembly. 3. Inspect electronic journal to dispenser communication cable for damage. Make sure the connectors are seated securely on the main board and on the electronic journal. 4. If it is necessary to check continuity of the cable assembly, refer to the appropriate ATM Service Manual for pin out of the cable assembly 5. If the cables are undamaged, the main board or electronic journal may be defective.
166	Bad dispense	<ol style="list-style-type: none"> 1. Open the Security Cabinet and inspect the cash dispenser for broken parts. Replace the dispenser if it is broken. Check for and clear any foreign matter the note path. 2. Reset the Cash Dispenser by turning OFF the AC power switch for a few seconds and switching it back ON. 3. Replace the dispenser if the error persists.
167	Reported low cash to Triton Connect	This is an indication that the cash in the cassette has gone below the threshold level set in the terminal configuration. This is a warning message that will not put the cash dispenser out of service.
168	Software download to terminal failed.	This is a Triton Connect error. Consult

182	Currency cassette low. Valid for SDD and GND mechanisms only.	With the low currency feature enabled, this error condition will occur before the cassette is actually empty. There should be about 1/4 inch of currency (approximately 60 bills) in the cassette when the error is detected. To clear an Error 182: 1. Reset the cash dispenser by switching the main power switch OFF for a few seconds and then switching it back ON. 2. Remove the cassette from the dispensing mechanism. 3. Press the reset error key. 4. Refill and install the cassette in the dispensing mechanism. 5. When the low currency function is disabled, the dispenser will dispense every note in the cassette then go "out of service" for an error code 33 (feed failure).
183	Receipt printer paper is low	1. Install a new roll of paper if needed. 2. If this does not correct the problem, verify that the paper low sensor is correctly attached to the paper bracket and that the cable between the paper low paper feed assembly and the docking assembly is undamaged and securely connected at both ends. 3. The paper low sensor may be dirty and require cleaning. 4. Otherwise, the possible causes of the problem may be a defective paper low sensor, cable, docking assembly or. A temporary fix to this problem may be to set the "low receipt paper" parameter to "in service" so that the terminal software does not read the input from the low paper sensor. When this is done, the terminal will operate normally until it is completely out of paper. Then it will go "out of service" for and error code 195 "out of paper".
185	Telephone number not configured	Enter Management Functions and configure the telephone number.
186	Bill Size not configured	This value is factory defaulted to \$0.00. Allowable bill sizes are 5, 10, 20, 50, and 100. Enter the Management Functions and configure the bill size.
187	Maximum withdrawal not configured	Enter the management functions and configure the "multiple amount" parameter. The maximum withdrawal cannot exceed 50 time the denomination of the bill size in the cassette.
188	PIN working key not configured	Enter the management functions and configure (download) the working key.
189	Terminal ID not configured	Enter the management functions and configure the "terminal ID" number.
190	PIN Master key not configured	Enter the management functions and configure the "PIN master key". Note: This error code is often caused by a SPED tamper. If you suspect SPED tamper or Error code 205, see the corrective action for Error Code 205.
191	Feed Failure	This error is usually associated with an empty note cassette or currency that is in "unfit" condition. 1. Refill the cassette as needed. 2. Inspect the cassette and feed path for currency that is stuck together or jammed. 3. If no jam is located, remove the first note from the cassette. Purge the dispenser. Do several test dispense operations. a. If the test dispenses are completed normally, and the return code are correct, clear all errors and place the cash dispenser in operation. b. If the test dispenser fails again, try testing while pushing in on the cassette. If it works then, the cassettes may not staying locked in the cassettes. Determine what is causing the cassette to not stay locked in place. 4. If the currency is in "fit" condition and the error persists, consider replacing the cassette or the dispenser.

192	Communication error	<ol style="list-style-type: none"> 1. Enter management functions and verify that all terminal parameters have been entered correctly. 2. Verify that the telephone line is operational. 3. Reset the Cash Dispenser by turning OFF the AC power switch for a few seconds and switching it back ON. Clear the error. 4. If the error persist, possible causes may be the modem or main board assembly.
194	An Attempt to Dispense is made the Cassettes are not Locked	<p>This is more of a status code then an error code. A dispense command was sent to the dispenser when no cassettes are locked or they are not in service.</p> <ol style="list-style-type: none"> 1. If working with an 8100, print a test receipt printer, Verify that the A cassette is in service. If not, place in service using the Cassette Service menu option. Purge then test dispense. If they pass, clear the error and place the ATM in service. 2. If working with a 9100, print a test receipt printer. Verify the "Cassette Summery". It should say Cassette A, B, C or D. Below Cassette Service on the receipt, verify that the cassette listed in Cassette Summery, is In Service. If not, place in service using the Cassette Service menu option. Purge then test dispense. If they pass, clear the error and place the ATM in service. 3. If working with a 96XX or 97XX ATM, with an NMD dispenser, lock the cassettes, then print the test receipt printer. Verify the "Cassette Summery". It should say Cassette A, B, C or D. Below Cassette Service on the receipt, verify that the cassette listed in Cassette Summery, is In Service. If not, place in service using the Cassette Service menu option. Purge then test dispense. If they pass, clear the error and place the ATM in service. 4. If working with an RL, FT or RT use The Cassette Parameters menu to lock the cassettes on an NMD dispenser, then verify the cassette name and status. Once the cassettes are in service, purge and test dispense. If they pass, clear the error and place the ATM in service. 5. If any of the above steps fail, there should be an error code displayed. Reference the error accordingly.
195	Receipt printer out of paper	<ol style="list-style-type: none"> 1. Replenish the paper. Reset the Cash Dispenser by turning OFF the AC power switch for a few seconds and switching it back ON. Clear the error. 2. Make sure that the ribbon cable from the docking station to the low paper sensor assembly is fastened at both ends of the cable and the orientation of the cable is correct. 3. If the error persists, possible causes of the problem may be the low paper sensor assembly, the docking station, the main board, or cables.
196	Card reader error	<ol style="list-style-type: none"> 1. Inspect the card reader assembly. Make sure that there is no foreign material in the card slot. 2. Clean the card reader assembly with a cleaning card. 3. Make sure the ribbon cable from the docking station to the card reader is fastened at both ends of the cable and the orientation of the cable is correct. 4. If the error persists, replace the card reader
203	SPED keypad is not replying to main board	<p>Status valid only for units with SPED keypad device installed.</p> <ol style="list-style-type: none"> 1. Make sure the battery is seated secure in the battery holder. 2. Make sure the tamper screw is secure to the SPED Module. Reset the Cash Dispenser by turning OFF the AC power switch for a few seconds and switching it back ON. Clear the error. 3. If the error persists, replace the SPED keypad module.
205	SPED keypad reported tamper condition	<p>Status valid only for units with SPED keypad device installed. Make sure the battery is seated secure in the battery holder. Make sure the tamper screw is secure to the SPED module. Reset the cash dispenser and clear the error. If the error persists, replace the SPED keypad module.</p>

206	SPED keypad could not perform a successful command within SPED_MAX_ATTEMPTS tries	Status valid only for units with SPED keypad device installed. Reset the cash dispenser and clear the error. If error persists, replace the SPED keypad module.
207	SPED not detected	This Error/Status Code is valid for units with SPED keypad device installed. 1. Check the cable and connections from J7A on the docking station to the SPED board. 2. Verify that the SPED board has the correct DC voltages applied to it. 3. If the DC voltages applied to the SPED board correct and the cables are in good condition and seated properly, replace the SPED board.
210	Dispenser type unknown	See Error Code 130
231	Card Reader Error (Smart Card)	
233	Smart Card Reader not installed	
236	Failed to make connection to TCP/IP host	The main board does not see any activity on the TCP-IP Communication. 1. If you are not using TCP-IP / Ethernet for transactions or Triton Connect, ensure you do not have TCP-IP selected for any option in processors, communications or Triton Connect. 2. Verify the quality of your incoming TCP-IP connection and your TCP-IP configuration. 3. Suspect the main board, the TCP-IP connection device (Quad Port Board in 96XX, Docking board on RL, FT or RT) or the TCP-IP equipment.
237	TCP/IP device failed	Out going commutations seems to be successful, but there is not returning communications. 1. Start by verify your communications settings and external TCP-IP equipment. 2. Verify the quality of your incoming TCP-IP connection and your TCP-IP configuration.3. Suspect the main board, the TCP-IP connection device (Quad Port Board in 96XX, Docking board on RL, FT or RT) or the TCP-IP equipment.
238	Power failure during dispense	A reset has occurred in the middle of a dispense. 1. This can be confirmed by referencing the electronic journal. Look for a reset entry directly after an incomplete transaction. 2. If resets are suspected, determine what could have caused the main board to reset. Suspect the ATM power supply, incoming power, the dispenser software or the main board / CPU.
239	SPED serial number change	The serial number stored in the software does not match the serial number of the VEPP. 1. Either the VEPP was changed or the software was reloaded, such as when you do a VEPP upgrade, or if the VEPP was changed. 2. Can only be cleared in Diagnostics>Keypad>Clear Tamper. On an 8 bit machine, such as 9100 or 9600, choose Diagnostics>More>More Keypad>Clear Tamper.
240	SPED Self Test Error	The SPED has returned an error during self test. 1. Reset the error. If error fails to reset, or the error reoccurs in a short amount of time, consider replacing the SPED.
241	SPED Warning: Self Test error, low battery	See Error Code 240
242	Stuck key	

243	Unable to display user defined surcharge screen	
244	Min. partial dispense enabled with no doc count	
245	Min. partial dispense enabled with no usable bills	
246	SPED password must be changed	The Master password must be changed from its default.
300	Successful Command	The NMD dispenser sends this status code when a command has been successfully executed. This status code will appear in the electronic journal as code 300 indicating the successful completion of a transaction. When performing a "purge" or "test dispense" operation the return code will be "0" in the first digit returned by the dispenser. It will be display as the hexadecimal number "30" when running the dispenser with the NMD test software.
301	Low level in cassette	This error code is returned by the dispenser when the number of notes in one or more of the cassettes is below a preset level, indicating the low level sensor in the note cassette has been activated. This occurs when the currency in any cassette reaches a thickness of approximately 25-35 mm. This is a warning message. It will not place the cash dispenser "out of service". This condition is also displayed on the configuration summary printout under "dispenser" as a lower case a, b, c, or d for the cassette in the low currency condition. Otherwise, the error code for cassettes not in a low currency condition would normally be upper case characters A, B, C, or D. Remove and fill the affected cassette using normal procedures. Refilling may be delayed for several transactions if the error code is the first warning that the cassette is nearly empty. However, actions to fill the cassette should be taken as soon as possible.
302	Empty cassette	This error code is generated when a cassette is empty or when it attempts to dispense and fails to pick. With Note Feeder 100 and 101 there is an empty sensor that check for notes in the cassettes with an optical sensor. Note Feeder 200 does not have this sensor. Either version of Note Feeder will report this error if there is a pick failure. The cash dispenser will attempt to complete the transaction from other cassettes. If the requested amount cannot be dispensed, the customer will receive the cash that can be dispensed. The transaction will be completed with the customers' receipt indicating the amount of cash actually received. The cash dispenser will then attempt to complete a Reversal Transaction to notify the financial institution of the error. 1. This error alone will not put the cash dispenser "out of service". It will cause that cassette to be taken "out of service". The cash dispenser will only be placed "out of service" when all cassettes are out of service". 2. Remove and refill the affected cassette using normal replenishment procedures.
303	Lifts are down	This error code is generated when a cassette is not open (locked) and any command other than open cassettes, reset, and close cassettes are sent to the system. It is feasible that this error code could be generated even if the lifts are in the up position. This will occur if the machine is switched off and on during normal daily operation. This is done to indicate that the power has been off. 1. Clear this error code by restarting the cash dispense or by unlocking and locking the cassettes. 2. If the error recurs, a faulty cassette, note feeder or CMC module may be cause the problem.

304	Rejected notes	This error code indicates that notes were rejected during the transaction or test dispense operation. This is a warning message there is no action required.
305	Diverter failure	This error code indicates that the system has recognized a document intended for the reject vault has reached the note transport sensor. The most probable cause is either mechanical or electrical failure of the note diverter in the note transport module. This error will place the cash dispenser "out of service". 1. Inspect the note diverter in the note transport module. Verify that there are no documents jammed in the note diverter area. Make sure the note diverter moves freely. Check to make sure that cables connecting the note transport and the CMC module are not damaged. Make sure all connectors attached to the CMC are seated in their receptacles. 2. Remove and empty the reject vault. Install the Reject Vault. Purge the dispensing mechanism. Complete several test dispenses. If the error does not repeat again, complete a live dispense to verify the note diverter moves the currency to the exit position. 3. If the error reoccurs the most likely causes of the problem may be note transport or CMC.
306	Failure to feed.	There are several possible reason for this error code being generated. One cause is that the note feeder fails to feed notes. Another cause is that there are to many single rejected notes in the transactions. 1. Check the condition of the currency to ensure is fit for dispensing. 2. Verify that the cassettes are operation correctly. Replace cassette as needed. 3. Check the operation of the note feeder sensors. Clean the note feeder sensors and needed. 4. Replace the noted feeder or note feeder controller as necessary.
307	Transmission Error	This error code occurs when the message received by the dispenser is incorrect. The reason that the error code is generated is the detection of an This error code occurs when the message received by the dispenser is incorrect. The reason that the error code is generated is the detection of an incorrect LRC character or a parity error. 1. Inspect all communication cables to make sure they are not damaged and are properly connect to their termination points. 2. Restart the cash dispenser. Reset the dispenser and try to complete a test dispense. 3. If the error code is reported again, replace the CMC module. Otherwise, put the cash dispenser into service.
308	Illegal command or command sequence	This error occurs when the logical sequence of the commands sent to the dispenser is not the one expected by the system. Examples of this are two move commands sent one after another or a deliver command that is sent without a previous move command. 1. Inspect all communication cables to make sure they are not damaged. Make sure all cables are properly connected. 2. Reset the dispenser and try to send the command that caused the error code. 3. If the error code is reported again, replace the CMC module.

309	Jam in Note Qualifier	This error code is generated when the note transport sensor does not detect a note that was detected by the note qualifier. This may be due to jammed documents in the transport path between the note qualifier and the note diverter. This error code will place the cash dispenser "out of service". 1. Inspect the documents in each cassette to insure they are in fit condition. Make sure that note qualifier and the note transport modules are mechanically aligned. Play close attention to the gears where the Note Qualifier and Note Transport meet. 2. Open all access panels and inspect for jammed documents in note path between the note qualifier and note transport. Remove the jammed documents as needed. 3. Inspect the note qualifier and note transport for broken components (belts, gears, cables, or sensors). 4. Inspect the note diverter for proper operation and damage. 5. Replace the note qualifier or note transport if the problem persists.
310	Cassette not properly installed.	This error code occurs when documents are requested from a cassette that is not present or is not open. This error code will place the cash dispenser in an "out of service" condition. 1. Verify the physical presence of each cassette. If present, "unlock" and remove each cassette from its feed channel. Put the cassettes back into its feed channel. Lock the cassettes. 2. Clear the error and perform a test dispense. If the error is repeated, proceed to the next paragraph. If the error does not show again put the cash dispenser back into service. 3. Verify that the identity of each cassette can be read through read cassette ID function. Cassettes with no identity must be injected with a new cassette ID. 4. If a cassette cannot be injected with a new ID, verify that the cable between the top feed channel and the CMC is in good condition and connected at both ends. 5. Try to inject an ID into another cassette. If the inject cassette ID function works on a different cassette. Then the original cassette is faulty. If the inject cassette ID function fails on a different cassette the CMC is defective.
311	Config record size invalid	
312	No notes retracted	This error code appears after the retract command is issued. This is a warning code only no action is required.
313	Cassette hopper map invalid	This error code occurs when one cassette has no cassette ID, or it has an ID that is incompatible with this cash dispenser. 1. Using inject cassette ID, send a new cassette ID to any cassette that is suspected until you have verified the ID of all cassettes 2. If one or more cassette can not have an ID resent, that cassette is suspect.
314	Dispenser offline - cannot resolve dispense count	
315	Reject vault not properly installed	This error code is generated when the reject vault is not present or not properly installed. Attempting to operate the cash dispenser without the reject vault will normally cause it to go to an "out of service" condition. 1. Make sure the reject vault is installed correctly. Note: a common mistake with the NMD 50 is to tuck the green handle under the reject vault. This handle should just dangle. 2. Inspect the reject vault present sensor visually for proper operation. 3. Use the cash dispenser diagnostic functions to check the electrical operation of the sensor. 4. If the sensor is properly connected and operating correctly the CMC module may be defective. If the sensor is not operating normally, replace the note transport module.

316	Delivery failure.	This error code is generated by the system when the bundle carrier unit fails to move the note from the home position to the delivery throat. 1. Inspect the transport path for damage. 2. Inspect the bundle carriage unit for proper alignment in the transport path. 3. Inspect the bundle carriage power connection at the CMC or Note Stacker Controller. 4. Reset the error code and utilize the dispenser diagnostic purge and test dispense functions to verify operation.
317	Reject failure	A reject command/movement failed. This may be a single or bundle reject failure. The bundle carriage unit failed to move from the home position to the reject position, back to the home position. 1. Inspect the note diverter for single reject failures. 2. Inspect the bundle carriage unit for bundle failures. 3. Inspect the transport path for damage. 4. Inspect the bundle carriage unit for proper alignment in the transport path. 5. Inspect the reject cassette. Consider replacing the reject vault 6. Inspect the bundle carriage power connection at the CMC or Note Stacker Controller. 7. Reset the error code and utilize the dispenser diagnostic purge and test dispense functions to verify operation. 8. This can be an electrical or mechanical failure, including the reject vault, the stacker unit, the note stacker controller or the CMC.
318	Too many notes requested	This error code occurs while running the dispenser on the NMD test software and when too many notes are requested during a dispense command. The maximum number of notes that can be dispensed from the dispenser during a transaction is defaulted to fifty. Retry the test operation and request fifty or fewer notes.
319	Jam in note transport	This error code is generated when a document from a note feeder fails to reach the note qualifier with in a specified time. This failure may be caused by a blockage in the transport path between the note feeder and the note qualifier, or if a document passes through the note qualifier unseen. This error code will cause the cash dispenser to go "out of service". 1. Check the cassettes. Make sure they are not overfilled. Make sure the documents are fit condition. 2. Open all access panels and remove any jammed documents from the transport path. Inspect the note feeders and note qualifier for damage. 3. Restart the cash dispenser. Reset the error. Complete several test dispenses. If the test dispenses are normal and the error does not show again, the cash dispenser may be returned to service. If the error recurs, change the note feeder for the affected channel.
320	Reject cassette almost full	This error code is generated when the number of reject events exceeds 37 events. Error code 320 will not put the cash dispenser "out of service". It is not displayed directly to the operator or customer. The error code will be sent to the Triton Connect host if Triton Connect feature is enabled. It will also be stored as part of the transaction data in the electronic journal. 1. The reject vault should be emptied as soon as possible in order to avoid an "out of service" condition that occurs when the number of reject events reaches 50. The reject event counter can be reset by removing the reject vault from the dispenser and then putting it back into the dispenser while power is applied to the dispenser.
321	Cassette data corrupted	This error code is generated when there is a checksum error in data stored in the note cassette. 1. Program the cassette by injecting a new cassette ID into the cassette. If injecting a new cassette ID into the cassette does not correct the problem, replace the cassette.

322	Main motor failure	<p>Error code 322 is generated when the main motor fails to reach normal speed with in a specified time, or if there are several pulses missing from the transport clock wheel (timing wheel) in one transaction. This error code causes an "Out of Service" condition.</p> <ol style="list-style-type: none"> 1. Open all access panels and remove any jammed documents from the transport path. Verify the documents are fit for dispensing. Inspect the note qualifier for any damage (broken belts, broken gears, disconnected or damaged cables, broken timing wheel or timing wheel sensor not locked into place etc.). Make sure all access panels are closed. 2. Restart the cash dispenser and reset the error. Complete several test dispenses. If cash dispenser operates normally when performing the test dispense function, put the cash dispenser in service. 3. If the error code repeats, verify the power supply output voltages are within expected values. Replace the power supply if necessary. 4. If the power supply is operating normally, replace the note qualifier to correct the problem.
323	Dispenser offline - Dispense count check error	
324	Reserved for warning status	
325	Note qualifier faulty	<p>Error code 325 is generated when the double detect sensors in the note qualifier can not be calibrated, or when the gain value cannot be adjusted when learning a new documents.</p> <ol style="list-style-type: none"> 1. Verify that the cable that connects the double detect module to the CMC module is undamaged and connected at both ends. 2. Make sure the access panel on the bottom of the note qualifier is closed and locked in position. 3. Carefully remove the double detect module from the note qualifier. Use clean compressed air to remove any dust or dirt from the sensor lenses. Carefully install the double detect module into the note qualifier. Make sure all connections between the double detect module and the CMC are seated properly. 4. If at any time during the following checks, the "faulty note qualifier" error code recurs. It will be necessary to replace the note qualifier. 5. Restart the cash dispenser. Reset the error the error code. If it clears, initiate the learn note thickness operation. Perform a test dispense. If cash dispenser operates normally, it will pick from seven to fifteen notes from each cassette to calibrate the double detect to the document in each of the cassettes. Then it will complete the test dispense function. Reference your service manual for definitions of a normal return code for this test dispense. 6. If the operation is normal, you may put the cash dispenser in service. If these check are not properly completed replace the note qualifier.
326	Note feed sensor failure	<p>This error code is generated when there is a sensor error in one or more of the note feeders or when there is a document jammed in the note feeder exit sensor.</p> <ol style="list-style-type: none"> 1. Make sure there are no documents jammed at any of note feeder exit sensors. 2. Check the calibration value for the pressure, empty, and exit sensors. If any sensor is out of its calibration limits, clean all of the sensors and attempt to do a transaction. 3. If error code reoccurs, replace the note feeder module.

327	Shutter failure	This error code is generated if the system fails to operate the shutter when required. 1. Reset the system. If the response to the reset command indicates successful execution, operation and be resumed. 2. If the problem persists, it may be necessary to replace the external shutter assembly, the shutter sensor board (if present), shutter cable, or the CMC module.
329	Notes in delivery throat	An attempt to feed or dispense documents has been made when there is a note in the note transport throat. 1. Remove any documents blocking the throat opening. Make sure the diverter is not jammed. Inspect the note transport for damage and verify that all connectors are plugged into their respective receptacles. 2. Use the reject channel error code function to verify the operation of the sensors on the note transport module. Clean the sensors in the note transport a needed. 3. Restart the cash dispenser. Reset the error code. Perform the test dispense function several times (two or three). Complete a live transaction. If the error does not show again put the cash dispenser into service. 4. If the error code returns, and a jam is not the cause, replace the note transport module.
330	Communication timeout	This error is reported when the transmission of each one of the characters in the command string is not completed within the time restriction imposed by the electrical interface. 1. Inspect all cables for damage. Verify that the both ends of each cable are securely connected to its termination points. This problem may be caused by incompatibilities between terminal software and dispensing mechanism software. 2. Check with Triton Systems Technical Support for known software incompatibilities.
332	Cassettes may have been changed	This error code is generated when a movement command is sent before read cassette ID command after the cassettes, including the reject vault are removed. This is error code will set an "out of service" condition. 1. Verify that each cassette is placed in a feed channel and the cassettes are locked. Complete the test receipt printer function to determine which if any of the cassettes are not responding. If a cassette is not responding it may be necessary to inject a new identity into the cassette by completing the inject new cassette ID command. 2. A defective cassette may also cause this problem.
333	Reject vault full	This error code is produced when the single reject event counter exceeds 50 reject events or the bundle reject event counter exceeds 250 notes. This error code will cause an "out of service" condition. 1. Remove all documents from the reject vault. To clear the error code, the reject vault must be removed and inserted with the power on. This will reset the reject event counters.
339	Error in throat	This error code is reported by the dispensing mechanism when a document is jammed in the throat sensor during a live dispenses or when a reset is performed. 1. Make sure all cables between the note transport and the other units are undamaged and securely seated at their termination point. 2. Check the operation of all sensors in the note transport module. Inspect the diverter area to make sure that it is not blocked and that it moves freely. Make sure that the access panels before and after the diverter are closed and secured in place. Remove any documents from the tote transport. 3. Restart the cash dispenser. Reset the error code. Perform a live transaction. If the cash dispenser operates normally put it back in service. 4. If the error code persists, replace the note transport module.

343	Sensor error or sensor covered	<p>With an NMD, this error is produced when a sensor in note transport module is not working correctly during an internal self-test preceding the movement commands.</p> <ol style="list-style-type: none"> 1. Inspect all cables for damage. Make sure that all cables are securely fastened to their termination points. 2. Open the access panels on the note transport and remove any documents that may be in the transport path. Access the error code command to determine if any sensors in the reject channel are dirty or defective. Clean the dirty sensor, or replace the note transport as needed. 3. Restart the cash dispenser. Reset the error. Perform a live transaction. If the cash dispenser operates normally put it in service. 4. If the problem persists, replace the note transport module. <p>With a TDM dispenser, this error is produced when a Width Sensor can not be calibrated.</p> <ol style="list-style-type: none"> 1. Run a dispenser status report (Click Counts) and reference the Width Sensor X Voltage Y (Note X= sensor 0, 1 or 2 in "Y"s feed channel. Y = the feed channel. A= feed channel 1, B = feed channel 2. C= feed channel 3 and D = feed channel 4). Cross reference the click counter section in your service manual to determine what click counts correspond to each feed channel and what sensor. 2. A clean, calibrated sensor will read just below 5.000vdc. A sensor that is hard to calibrate will read closer to 2.000vdc. As an example, 4.867 would be a good sensor. 1.985 would be a suspect sensor. 3. Inspect and clean any suspect sensors with clean compressed air 4. Restart the cash dispenser. Reset the error. Perform test dispenses. If the cash dispenser operates normally put it in service.
348	Dispenser internal error.	<p>This error code is reported when an internal error occurs in the dispenser. The most likely cause is internal communication problems within the dispenser.</p> <ol style="list-style-type: none"> 1. Inspect all cables for possible damage. Ensure that each cable is securely fastened to its termination point. 2. Restart the cash dispenser. Reset the error. If the response to the RESET command indicates a successful execution, put the cash dispenser back in service. 3. If the error code is reported again, it may be necessary to replace the CMC or one of the note feeder controllers.
349	Cassette lock faulty	<p>This error code is generated when the LIFTS UP command fails to open a note cassette to the operating position.</p> <ol style="list-style-type: none"> 1. Verify that the currency is properly installed in the cassette. If necessary, reload the currency in the cassette. 2. If the problem remains after reloading the cassette, replace the cassette, the denomination extension, or the note feeder controller associated with the cassette causing the problem.
350	Jam in note stacker	<p>This status may be generated:A) When a note is jammed in the note stacker,B) When the note stacker is not turning, C) Or when the bundle carriage unit cannot move.</p> <ol style="list-style-type: none"> 1. Inspect for and clear any jammed notes that are found in the note stacker. Clean all sensors as needed. 2. Reset the error. If the error persists, it may be necessary to replace the note stacker or the CMC module.

351	Module needs service	This error code is generated by the dispensing mechanism when the calibration value for at least one of the sensors in any of the note feeders has exceeded the upper limits of its calibration range. 1. Use the diagnostic functions or NMD test software to determine if a note feeder has a faulty or dirty sensor. 2. Remove each note feeder module from the dispensing mechanism and clean their associated empty, pressure and exit sensors with clean compressed air. 3. Install the note feeders and recheck their operation to determine if the error code has been cleared. If the error code has been cleared, the cash dispenser can be put back in service. If the error code is repeated, replace the note feeder or note feeder controller for the affected feed channel.
353	No message to resend	This error code may indicate a power loss/firmware restart has occurred at the dispenser controller and no information could be retrieved. 1. Restart the cash dispenser. Reset the error. Perform several test dispenses. 2. If the cash dispenser operates normally while performing a test dispense, put it back into service. 3. If the error code recurs, there may be a problem with the CMC module.
356	Error in note transport	This error code will be generated when the following conditions occur: A) When the note is stuck in the note transport sensor. B) When the note is stuck in between the note transport sensor and the throat. 1. Inspect the note transport sensor for blockage. If the sensor is blocked, remove the blockage. Clean the sensors if needed. 2. Restart the cash dispenser. Reset the error. If the error code continues, replace the note transport module. Otherwise, put the cash dispenser into service.
357	Dispenser data size error	Restart the operating system. Clear terminal error code. This problem may be resolved by replacing the CMC board or by replacing the dispenser mechanism.
358	Dispenser device read error	Restart the operating system. Clear terminal error code. This problem may be resolved by replacing the CMC board or by replacing the dispenser mechanism.
359	Dispenser device record error	Restart the operating system. Clear terminal error code. This problem may be resolved by replacing the CMC board or by replacing the dispenser mechanism.
360	Dispenser invalid return ID	Restart the operating system. Clear terminal error code. This problem may be resolved by replacing the CMC board or by replacing the dispenser mechanism.
361	Dispenser sequence error	Restart the operating system. Clear terminal error code. This problem may be resolved by replacing the CMC board or by replacing the dispenser mechanism.
362	Dispenser device write error	Restart the operating system. Clear terminal error code. This problem may be resolved by replacing the CMC board or by replacing the dispenser mechanism.
363	Dispenser device not found	Restart the operating system. Clear terminal error code. This problem may be resolved by replacing the CMC board or by replacing the dispenser mechanism.
364	Dispenser device offline	Restart the operating system. Clear terminal error code. This problem may be resolved by replacing the CMC board or by replacing the dispenser mechanism.
365	Dispenser BCC error	Restart the operating system. Clear terminal error code. This problem may be resolved by replacing the CMC board or by replacing the dispenser mechanism.
366	Dispenser cassettes disabled	Access management functions and enable cassettes. Make sure that the cassettes are physically removed and inserted into each bin before clearing the error

367	Dispenser communication error.	Check the dispenser data and power cable connections. Restart the operating system. Clear terminal error code. This problem may be resolved by replacing the CMC board or by replacing the dispenser mechanism.
368	Dispenser cannot dispense the request	Requested amount may exceed the dispensers one time limit. Enter a smaller value. If error persists, it may be necessary to replace the dispenser mechanism.
369	Dispenser device reset	Check data and power connections to the dispenser device. Clear terminal error code. This problem may be resolved by replacing the CMC board or by replacing the dispenser mechanism.
370	Dispenser - EOT error	Check data and power connections to the dispenser device. Clear terminal error code. This problem may be resolved by replacing the CMC board or by replacing the dispenser mechanism.
371	Dispenser com error header-trailer	Check data and power connections to the dispenser device. Clear terminal error code. This problem may be resolved by replacing the CMC board or by replacing the dispenser mechanism.
372	Dispenser item value error	Clear terminal error code and retry previous request. This problem may be resolved by replacing the CMC board or by replacing the dispenser mechanism.
373	Dispenser machine not opened	Access the management functions menu and lock all cassettes. Verify that all cassettes used are in service.
374	Dispenser rejected check	Clear terminal error code. This problem may be resolved by replacing the CMC board or by replacing the dispenser mechanism.
375	Dispenser invalid request	Clear terminal error code and retry previous request. This problem may be resolved by replacing the CMC board or by replacing the dispenser mechanism.
376	Dispenser multiple device error	Restart operating system. Clear terminal error code and retry previous request. This problem may be resolved by replacing the CMC board or by replacing the dispenser mechanism.
377	Dispenser device error	Restart operating system. Clear terminal error code and retry previous request. This problem may be resolved by replacing the CMC board or by replacing the dispenser mechanism.
378	Dispenser cassette low	
379	Dispenser unknown error code	Restart operating system. Clear terminal error code and retry previous request. This problem may be resolved by replacing the CMC board or by replacing the dispenser mechanism.
380	Dispenser setup incomplete	Check and verify that all dispenser configuration have been entered into the terminal parameters.
381	Dispenser cassette invalid	See error code 321
382	Dispenser cassettes disabled (ALL)	The error indicates that all cassettes were taken out of service. Cassettes are take out of service for two reasons:A) Feed failure or empty. See Error Code 101, 302 or 306B) Excessive rejects. See Error Code 481. Once the cause has been resolved, place desired cassettes into service and reset the error.
383	Dispense cassettes low (ALL)	All cassettes have reached low cash level. Reload cassettes. Clear terminal error code.
384	Dispenser cassettes empty (ALL)	All cassettes report no notes. Replenish cassettes. Clear terminal error code.
385	Dispenser offline, no reject vault and no hoppers	Verify that the dispenser mechanism has data and power cable connected. Verify power is applied to the dispenser
386	Dispenser offline - no hoppers	The hoppers are not detected. Check the computer area network connectors in the dispenser. Restart operating system. Clear terminal error code. If error persists, replace the dispenser mechanism.

387	Dispenser offline - error-validating configuration	Dispenser failed to identify the dispenser type installed. 1. Verify all connectors to the dispenser mechanism. 2. Restart operating system. Clear terminal error code. 3. If error persists, replace the dispenser mechanism or the CMC of an NMD dispenser
388	Dispenser offline - NMD require Reject Vault and at least one cassette	Verify that the Reject Vault and one cassette are present in the dispenser mechanism. Clear terminal error code. If error persists, replace the dispenser mechanism
389	Dispenser offline. Detected offline error check op state	Restart the operating system. Verify the error code lights on the dispenser are operating in proper sequence. Use the NMD test software (available to Triton Certified Service Technicians) and verify the operational error code of the dispenser.
390	Dispenser offline - storing configuration	Restart the operating system. Verify the error code lights on the dispenser are operating in proper sequence. Use the NMD test software (available to Triton Certified Service Technicians) and verify the operational error code of the dispenser.
391	Dispenser sensor failure 2	Access the management function diagnostics menus to verify the operational error code of dispenser mechanism sensors. Clean sensors as needed. Replace dispenser components or dispenser if the error persists.
392	Error in last dispense	Check operational error code of dispenser. This problem may be resolved by replacing the CMC board or by replacing the dispenser mechanism.
393	Error in double detect 2	
394	Purge failed upon power-up	
395	Multiple cassette of the same type	NMD dispenser allows for only one of each cassette ID to be installed. Verify each cassette ID. Replace cassette or Inject New Cassette ID.
396	Dispenser offline – found no reject bin	
500	SPED Read Error	Verify all SPED connections. Restart the operating system. Clear any errors conditions. Inspect the battery for a voltage reading of greater than 2.8 VDC. Replace SPED battery is below 2.8 VDC. Replace SPED module if error persists.
501	SPED invalid return record	Verify all SPED connections. Restart the operating system. Clear any errors conditions. Inspect the battery for a voltage reading of greater than 2.8 VDC. Replace SPED battery is below 2.8 VDC. Replace SPED module if error persists.
502	SPED read type error	Verify all SPED connections. Restart the operating system. Clear any errors conditions. Inspect the battery for a voltage reading of greater than 2.8 VDC. Replace SPED battery is below 2.8 VDC. Replace SPED module if error persists.
503	SPED invalid command	Verify all SPED connections. Restart the operating system. Clear any errors conditions. Inspect the battery for a voltage reading of greater than 2.8 VDC. Replace SPED battery is below 2.8 VDC. Replace SPED module if error persists.
504	SPED invalid return ID	Verify all SPED connections. Restart the operating system. Clear any errors conditions. Inspect the battery for a voltage reading of greater than 2.8 VDC. Replace SPED battery is below 2.8 VDC. Replace SPED module if error persists.
505	SPED device busy	Verify all SPED connections. Restart the operating system. Clear any errors conditions. Inspect the battery for a voltage reading of greater than 2.8 VDC. Replace SPED battery is below 2.8 VDC. Replace SPED module if error persists.
506	SPED invalid request	Verify all SPED connections. Restart the operating system. Clear any errors conditions. Inspect the battery for a voltage reading of greater than 2.8 VDC. Replace SPED battery is below 2.8 VDC. Replace SPED module if error persists.

507	SPED sequence error	Verify all SPED connections. Restart the operating system. Clear any errors conditions. Inspect the battery for a voltage reading of greater than 2.8 VDC. Replace SPED battery is below 2.8 VDC. Replace SPED module if error persists.
508	SPED LRC error	Verify all SPED connections. Restart the operating system. Clear any errors conditions. Inspect the battery for a voltage reading of greater than 2.8 VDC. Replace SPED battery is below 2.8 VDC. Replace SPED module if error persists.
509	SPED no data	Verify all SPED connections. Restart the operating system. Clear any errors conditions. Inspect the battery for a voltage reading of greater than 2.8 VDC. Replace SPED battery is below 2.8 VDC. Replace SPED module if error persists.
510	SPED invalid message ID	Verify all SPED connections. Restart the operating system. Clear any errors conditions. Inspect the battery for a voltage reading of greater than 2.8 VDC. Replace SPED battery is below 2.8 VDC. Replace SPED module if error persists.
511	SPED Data overflow	Verify all SPED connections. Restart the operating system. Clear any errors conditions. Inspect the battery for a voltage reading of greater than 2.8 VDC. Replace SPED battery is below 2.8 VDC. Replace SPED module if error persists.
512	SPED device idle	Verify all SPED connections. Restart the operating system. Clear any errors conditions. Inspect the battery for a voltage reading of greater than 2.8 VDC. Replace SPED battery is below 2.8 VDC. Replace SPED module if error persists.
513	SPED device offline	Verify all SPED connections. Restart the operating system. Clear any errors conditions. Inspect the battery for a voltage reading of greater than 2.8 VDC. Replace SPED battery is below 2.8 VDC. Replace SPED module if error persists.
514	SPED device bit stuck	Verify all SPED connections. Restart the operating system. Clear any errors conditions. Inspect the battery for a voltage reading of greater than 2.8 VDC. Replace SPED battery is below 2.8 VDC. Replace SPED module if error persists.
515	SPED device attention stuck	Verify all SPED connections. Restart the operating system. Clear any errors conditions. Inspect the battery for a voltage reading of greater than 2.8 VDC. Replace SPED battery is below 2.8 VDC. Replace SPED module if error persists.
516	SPED device no attention	Verify all SPED connections. Restart the operating system. Clear any errors conditions. Inspect the battery for a voltage reading of greater than 2.8 VDC. Replace SPED battery is below 2.8 VDC. Replace SPED module if error persists.
517	SPED device timeout	Verify all SPED connections. Restart the operating system. Clear any errors conditions. Inspect the battery for a voltage reading of greater than 2.8 VDC. Replace SPED battery is below 2.8 VDC. Replace SPED module if error persists.
518	SPED command sequence error	Verify all SPED connections. Restart the operating system. Clear any errors conditions. Inspect the battery for a voltage reading of greater than 2.8 VDC. Replace SPED battery is below 2.8 VDC. Replace SPED module if error persists.
519	SPED invalid command data	Verify all SPED connections. Restart the operating system. Clear any errors conditions. Inspect the battery for a voltage reading of greater than 2.8 VDC. Replace SPED battery is below 2.8 VDC. Replace SPED module if error persists.
520	SPED device reset	Verify all SPED connections. Restart the operating system. Clear any errors conditions. Inspect the battery for a voltage reading of greater than 2.8 VDC. Replace SPED battery is below 2.8 VDC. Replace SPED module if error persists.
521	SPED clear key	Verify all SPED connections. Restart the operating system. Clear any errors conditions. Inspect the battery for a voltage reading of greater than 2.8 VDC. Replace SPED battery is below 2.8 VDC. Replace SPED module if error persists.

522	EJ error	Restart operating system. If the problem persists, it may be necessary to replace the ATM main board assembly on Xscale systems, or the PC assembly or hard drive on the xp or 9800 systems..
523	EJ data size error	Restart operating system. If the problem persists, it may be necessary to replace the ATM main board assembly on Xscale systems, or the PC assembly or hard drive on the xp or 9800 systems..
524	EJ bad command	Restart operating system. If the problem persists, it may be necessary to replace the ATM main board assembly on Xscale systems, or the PC assembly or hard drive on the xp or 9800 systems..
525	EJ invalid ID	Restart operating system. If the problem persists, it may be necessary to replace the ATM main board assembly on Xscale systems, or the PC assembly or hard drive on the xp or 9800 systems..
526	EJ device busy	Restart operating system. If the problem persists, it may be necessary to replace the ATM main board assembly on Xscale systems, or the PC assembly or hard drive on the xp or 9800 systems..
527	EJ invalid request	Restart operating system. If the problem persists, it may be necessary to replace the ATM main board assembly on Xscale systems, or the PC assembly or hard drive on the xp or 9800 systems..
528	EJ sequence error	Restart operating system. If the problem persists, it may be necessary to replace the ATM main board assembly on Xscale systems, or the PC assembly or hard drive on the xp or 9800 systems..
529	EJ device offline	Restart operating system. If the problem persists, it may be necessary to replace the ATM main board assembly on Xscale systems, or the PC assembly or hard drive on the xp or 9800 systems..
530	EJ EXT error	Restart operating system. If the problem persists, it may be necessary to replace the ATM main board assembly on Xscale systems, or the PC assembly or hard drive on the xp or 9800 systems..
531	EJ SOH error	Restart operating system. If the problem persists, it may be necessary to replace the ATM main board assembly on Xscale systems, or the PC assembly or hard drive on the xp or 9800 systems..
532	EJ STX error	Restart operating system. I the problem persists, it may be necessary to replace the ATM main board assembly on Xscale systems, or the PC assembly or hard drive on the xp or 9800 systems..
533	EJ BCC error	Restart operating system. If the problem persists, it may be necessary to replace the ATM main board assembly on Xscale systems, or the PC assembly or hard drive on the xp or 9800 systems..
534	EJ device reset	Restart operating system. If the problem persists, it may be necessary to replace the ATM main board assembly on Xscale systems, or the PC assembly or hard drive on the xp or 9800 systems..
535	Card Reader - Data size error	Inspect card reader cabling. Inspect card reader for foreign objects. Clean the card reader with an approved cleaning device. Clear the terminal error code. Reboot the ATM. If error persists, replace the card reader.
536	Card Reader - Device read error	Inspect card reader cabling. Inspect card reader for foreign objects. Clean the card reader with an approved cleaning device. Clear the terminal error code. Reboot the ATM. If error persists, replace the card reader.
537	Card Reader - Invalid Record	Inspect card reader cabling. Inspect card reader for foreign objects. Clean the card reader with an approved cleaning device. Clear the terminal error code. Reboot the ATM. If error persists, replace the card reader.
538	Card Reader - Reader type error	Inspect card reader cabling. Inspect card reader for foreign objects. Clean the card reader with an approved cleaning device. Clear the terminal error code. Reboot the ATM. If error persists, replace the card reader.

539	Card Reader - Invalid track	Inspect card reader cabling. Inspect card reader for foreign objects. Clean the card reader with an approved cleaning device. Clear the terminal error code. Reboot the ATM. If error persists, replace the card reader.
540	Card Reader - Invalid message	Inspect card reader cabling. Inspect card reader for foreign objects. Clean the card reader with an approved cleaning device. Clear the terminal error code. Reboot the ATM. If error persists, replace the card reader.
541	Card Reader - Com error	Inspect card reader cabling. Inspect card reader for foreign objects. Clean the card reader with an approved cleaning device. Clear the terminal error code. Reboot the ATM. If error persists, replace the card reader.
542	Card Reader - Device busy	Inspect card reader cabling. Inspect card reader for foreign objects. Clean the card reader with an approved cleaning device. Clear the terminal error code. Reboot the ATM. If error persists, replace the card reader.
543	Card Reader - Sequence error	Inspect card reader cabling. Inspect card reader for foreign objects. Clean the card reader with an approved cleaning device. Clear the terminal error code. Reboot the ATM. If error persists, replace the card reader.
544	Card Reader - Invalid request	Inspect card reader cabling. Inspect card reader for foreign objects. Clean the card reader with an approved cleaning device. Clear the terminal error code. Reboot the ATM. If error persists, replace the card reader.
545	Card Reader - LRC error	Inspect card reader cabling. Inspect card reader for foreign objects. Clean the card reader with an approved cleaning device. Clear the terminal error code. Reboot the ATM. If error persists, replace the card reader.
546	Card Reader - No data	Inspect card reader cabling. Inspect card reader for foreign objects. Clean the card reader with an approved cleaning device. Clear the terminal error code. Reboot the ATM. If error persists, replace the card reader.
547	Card Reader - Start sentinel not found	Inspect card reader cabling. Inspect card reader for foreign objects. Clean the card reader with an approved cleaning device. Clear the terminal error code. Reboot the ATM. If error persists, replace the card reader.
548	Card Reader - End sentinel not found	Inspect card reader cabling. Inspect card reader for foreign objects. Clean the card reader with an approved cleaning device. Clear the terminal error code. Reboot the ATM. If error persists, replace the card reader.
549	Card Reader - Parity error	Inspect card reader cabling. Inspect card reader for foreign objects. Clean the card reader with an approved cleaning device. Clear the terminal error code. Reboot the ATM. If error persists, replace the card reader.
550	Card Reader - Card not removed	Inspect card reader cabling. Inspect card reader for foreign objects. Clean the card reader with an approved cleaning device. Clear the terminal error code. Reboot the ATM. If error persists, replace the card reader.
551	Card Reader - Card removed to slow	Inspect card reader cabling. Inspect card reader for foreign objects. Clean the card reader with an approved cleaning device. Clear the terminal error code. Reboot the ATM. If error persists, replace the card reader.
552	Card Reader - Device received invalid request	Inspect card reader cabling. Inspect card reader for foreign objects. Clean the card reader with an approved cleaning device. Clear the terminal error code. Reboot the ATM. If error persists, replace the card reader.
553	Card Reader - device offline	Inspect card reader cabling. Inspect card reader for foreign objects. Clean the card reader with an approved cleaning device. Clear the terminal error code. Reboot the ATM. If error persists, replace the card reader.

554	Card Reader - device reset	Inspect card reader cabling. Inspect card reader for foreign objects. Clean the card reader with an approved cleaning device. Clear the terminal error code. Reboot the ATM. If error persists, replace the card reader.
555	Card Reader - System timeout	Inspect card reader cabling. Inspect card reader for foreign objects. Clean the card reader with an approved cleaning device. Clear the terminal error code. Reboot the ATM. If error persists, replace the card reader.
556	System timeout	An operating system timeout has occurred. Check operation of the power supply. Restart ATM. Clear the error. If error persists, it may be necessary to reload the operating system software or replace the ATM main board assembly.
557	System device reset	An operating system timeout has occurred. Check operation of the power supply. Restart ATM. Clear the error. If error persists, it may be necessary to reload the operating system software or replace the ATM main board assembly.
558	System sync error	An operating system timeout has occurred. Check operation of the power supply. Restart ATM. Clear the error. If error persists, it may be necessary to reload the operating system software or replace the ATM main board assembly.
559	System error	An operating system timeout has occurred. Check operation of the power supply. Restart ATM. Clear the error. If error persists, it may be necessary to reload the operating system software or replace the ATM main board assembly.
560	Unknown device error	An operating system timeout has occurred. Check operation of the power supply. Restart ATM. Clear the error. If error persists, it may be necessary to reload the operating system software or replace the ATM main board assembly.
561	Software error	
562	SPED error	Inspect cable from Main Board assembly to the SPED module for damage. Make sure that cable is connected at both ends. Verify that the DC operating voltages are correct. Restart ATM. Clear the error. If error persists, replace the SPED module.
563	Low Memory	
564	Unable to access external memory device	
565	Cabinet door open	Close the control panel door. Reset error code. If error persists, verify the operation of cabinet door switch. Replace as needed.
566	Vault door open	Close vault door. Reset error code. If error persists, check the operation of the vault door switch. Replace as needed
567	Security module not found	See Error Code 568
568	Security module com failed	This error indicates that the communications from the security module to the main board is not operational. 1. Inspect cable from security module to the docking board for damage. Make sure that the cable is connected at both ends. 2. Restart ATM. Clear the error. If error persists, suspect the security module, cable from the security module to the docking board, the docking board and the main board.
569	Security module attached dev com failed	This error indicates that the communications from the security module to the dispenser is not operational. 1. Inspect cable from security module to the dispenser for damage. Make sure that the cable is connected at both ends. 2. Inspect the dispenser (Follow steps for Error Code 130). 3. Restart ATM. Clear the error. If error persists, suspect the security module, cable from the security module to the dispenser, the dispenser, power to the dispenser.

570	Security module dev port setup	Inspect cable from main board assembly to the security module for damage. Make sure that the cable is connected at both ends. Restart ATM. Clear the error. If error persists, replace the security module.
571	Invalid default transaction	TBD
572	SPED key from pad cmd aborted by user	Inspect cable from docking board assembly to the SPED module for damage. Make sure that the cable is connected at both ends. Restart ATM. Clear the error. If error persists, it may be necessary to replace the main board, the docking board, the SPED module or related cabling.
573	SPED keys from pad cmd verify failed	Inspect cable from docking board assembly to the SPED module for damage. Make sure that the cable is connected at both ends. Restart ATM. Clear the error. If error persists, it may be necessary to replace the main board, the docking board, the SPED module or related cabling.
574	SNA comms error	To be determined
575	Timeout waiting to send command to dispenser	Inspect the serial communication cables from the main board assembly to the dispenser for damage. Make sure that each end of the cable is connected securely. Replace the cable if it appear damaged. Check the power supply for the proper DC operating voltages and that they are applied to the dispenser mechanism. Possible defective components include main board assembly, the docking board, the serial communications cables, the DC power cables, the power supply, and the dispenser mechanism.
576	Timeout waiting to receive response from dispenser	Inspect the serial communication cables from the main board assembly to the dispenser for damage. Make sure that each end of the cable is connected securely. Replace the cable if it appear damaged. Check the power supply for the proper DC operating voltages and that they are applied to the dispenser mechanism. Possible defective components include main board assembly, the docking board, the serial communications cables, the DC power cables, the power supply, and the dispenser mechanism.
577	Card reader disabled	Inspect card reader cable. Inspect the card reader for foreign objects. Replace the cable or clean the card reader as needed. Clear the error. Restart the ATM. If the error persists, replace the card reader.
578	Card reader present timeout	Inspect card reader cable. Inspect the card reader for foreign objects. Replace the cable or clean the card reader as needed. Clear the error. Restart the ATM. If the error persists, replace the card reader.
579	SPED - Enable keypad command failed	Inspect cable from docking assembly to the SPED Module for damage. Make sure that the cable is connected at both ends. Verify that the DC operating voltages are correct. Restart ATM. Clear the error. If error persists, replace the SPED module.
580	SPED - Disable keypad command failed	Inspect cable from docking assembly to the SPED Module for damage. Make sure that the cable is connected at both ends. Verify that the DC operating voltages are correct. Restart ATM. Clear the error. If error persists, replace the SPED module.
581	SPED - Enable key from pad module failed	Inspect cable from docking assembly to the SPED Module for damage. Make sure that the cable is connected at both ends. Verify that the DC operating voltages are correct. Restart ATM. Clear the error. If error persists, replace the SPED module.
582	SPED - Disable key from pad module	Inspect cable from docking assembly to the SPED Module for damage. Make sure that the cable is connected at both ends. Verify that the DC operating voltages are correct. Restart ATM. Clear the error. If error persists, replace the SPED module.
583	SPED - Enable PIN entry mode failed	Inspect cable from docking assembly to the SPED Module for damage. Make sure that the cable is connected at both ends. Verify that the DC operating voltages are correct. Restart ATM. Clear the error. If error persists, replace the SPED module.
584	SPED - Disable PIN entry mode failed	Inspect cable from docking assembly to the SPED Module for damage. Make sure that the cable is connected at both ends. Verify that the DC operating voltages are correct. Restart ATM. Clear the error. If error persists, replace the SPED module.

585	SPED - Enable JETCO PIN entry mode failed	Inspect cable from docking assembly to the SPED Module for damage. Make sure that the cable is connected at both ends. Verify that the DC operating voltages are correct. Restart ATM. Clear the error. If error persists, replace the SPED module.
586	SPED - Enable JETCO PIN entry mode failed	Inspect cable from docking assembly to the SPED Module for damage. Make sure that the cable is connected at both ends. Verify that the DC operating voltages are correct. Restart ATM. Clear the error. If error persists, replace the SPED module.
587	NMD 50 required Cassette in TOP hopper	
588	ERR PRESENTER OFFLINE	Verify that a cable from the docking board to the presenter controller board is securely connected at both ends. If the cable appears undamaged, and it is securely connected at the docking board and the presenter controller board, replace the presenter assembly. If replacing the presenter does not clear the error, other possible causes of this problem may be the main board assembly or the docking board.
589	ERR PRESENTER MOTOR STALLED	Inspect the gears assembly on the presenter for possible damage. Replace the presenter if gear damage is apparent. Open printer and inspect the presenter paper path for jammed paper. Remove any jammed paper or other debris.
590	ERR PRESENTER EXIT JAM	Open printer and inspect the presenter paper path for jammed paper. Remove any jammed paper or other debris. Restart the cash dispenser. If the error persist, replace the presenter module.
591	ERR PRESENTER PAPER NOT DETECTED	Open the printer and verify that the paper is not jamming in the printer between the printer output and the input to the cutter. Clear all debris from the printer path. Restart the ATM. If the paper continues to jam, it may be necessary to replace the cutter or printer. If replacing the printer or cutter does not clear the error replace the presenter module.
592	ERR SPED DEVICE REPORTED FAILED	Inspect cable from main board assembly to the SPED module for damage. Make sure that the cable is connected at both ends. Verify that the DC operating voltages are correct. Restart ATM. Clear the error. If error persists, replace the SPED module.
593	ERR SPED IN USE	Inspect cable from main board assembly to the SPED module for damage. Make sure that the cable is connected at both ends. Verify that the DC operating voltages are correct. Restart ATM. Clear the error. If error persists, replace the SPED module.
594	ERR SPED DEVICE REPORTED COMM ERROR	Inspect cable from main board assembly to the SPED module for damage. Make sure that the cable is connected at both ends. Verify that the DC operating voltages are correct. Restart ATM. Clear the error. If error persists, replace the SPED module.
595	ERR SPED RETURN INVALID AMOUNT OF DATA	Inspect cable from main board assembly to the SPED module for damage. Make sure that the cable is connected at both ends. Verify that the DC operating voltages are correct. Restart ATM. Clear the error. If error persists, replace the SPED module.
596	ERR SPED INVALID SPED TYPE	Inspect cable from main board assembly to the SPED module for damage. Make sure that the cable is connected at both ends. Verify that the DC operating voltages are correct. Restart ATM. Clear the error. If error persists, replace the SPED module.
597	ERR SPED INVALID SPED COMMS PROTOCOL	Inspect cable from main board assembly to the SPED module for damage. Make sure that the cable is connected at both ends. Verify that the DC operating voltages are correct. Restart ATM. Clear the error. If error persists, replace the SPED module.
598	ERR_SPED_INVALID_DEVICE_CLASS	Inspect cable from main board assembly to the SPED module for damage. Make sure that the cable is connected at both ends. Verify that the DC operating voltages are correct. Restart ATM. Clear the error. If error persists, replace the SPED module.
599	ERR SPED REPORTED UNRECOGNIZED COMMAND	Inspect cable from main board assembly to the SPED module for damage. Make sure that the cable is connected at both ends. Verify that the DC operating voltages are correct. Restart ATM. Clear the error. If error persists, replace the SPED module.
600	ERR SPED REPORTED BLOCK DOES NOT EXIST	Inspect cable from main board assembly to the SPED module for damage. Make sure that the cable is connected at both ends. Verify that the DC operating voltages are correct. Restart ATM. Clear the error. If error persists, replace the SPED module.

		replace the SPED module.
601	ERR SPED REPORTED INVALID ENCRYPT MODE	Inspect cable from main board assembly to the SPED module for damage. Make sure that the cable is connected at both ends. Verify that the DC operating voltages are correct. Restart ATM. Clear the error. If error persists, replace the SPED module.
602	ERR SPED REPORTED UNSUPPORTED CLEAR OPTION	Inspect cable from main board assembly to the SPED module for damage. Make sure that the cable is connected at both ends. Verify that the DC operating voltages are correct. Restart ATM. Clear the error. If error persists, replace the SPED module.
603	ERR SPED REPORTED TAMPER PRESENT	Inspect cable from main board assembly to the SPED module for damage. Make sure that the cable is connected at both ends. Verify that the DC operating voltages are correct. Restart ATM. Clear the error. If error persists, replace the SPED module.
604	ERR SPED REPORTED INVALID KEY INDEX	Inspect cable from main board assembly to the SPED module for damage. Make sure that the cable is connected at both ends. Verify that the DC operating voltages are correct. Restart ATM. Clear the error. If error persists, replace the SPED module.
605	ERR SPED REPORTED PARENT KEY NOT LOADED	Inspect cable from main board assembly to the SPED module for damage. Make sure that the cable is connected at both ends. Verify that the DC operating voltages are correct. Restart ATM. Clear the error. If error persists, replace the SPED module.
606	ERR SPED REPORTED WRONG DATA LENGTH	Inspect cable from main board assembly to the SPED module for damage. Make sure that the cable is connected at both ends. Verify that the DC operating voltages are correct. Restart ATM. Clear the error. If error persists, replace the SPED module.
607	ERR SPED REPORTED PIN RETRY TOO SOON	Inspect cable from main board assembly to the SPED module for damage. Make sure that the cable is connected at both ends. Verify that the DC operating voltages are correct. Restart ATM. Clear the error. If error persists, replace the SPED module.
608	ERR SPED SELFTEST CRC FAILED	Inspect cable from main board assembly to the SPED module for damage. Make sure that the cable is connected at both ends. Verify that the DC operating voltages are correct. Restart ATM. Clear the error. If error persists, replace the SPED module.
609	ERR SPED SELFTEST CRYPTOGRAPHIC ERROR	Inspect cable from main board assembly to the SPED module for damage. Make sure that the cable is connected at both ends. Verify that the DC operating voltages are correct. Restart ATM. Clear the error. If error persists, replace the SPED module.
610	ERR SPED SELFTEST BATTERY LOW STATUS	Inspect cable from main board assembly to the SPED module for damage. Make sure that the cable is connected at both ends. Verify that the DC operating voltages are correct. Restart ATM. Clear the error. If error persists, replace the SPED module.
611	ERR SPED SELFTEST SERIAL NUMBER ERROR	Inspect cable from main board assembly to the SPED module for damage. Make sure that the cable is connected at both ends. Verify that the DC operating voltages are correct. Restart ATM. Clear the error. If error persists, replace the SPED module.
612	ERR SPED TAMPER STATUS COLD	Verify all SPED connections. Restart the operating system. Clear any errors conditions. Inspect the battery for a voltage reading of greater than 2.8 VDC. Replace SPED battery is below 2.8 VDC. Replace SPED module if error persists.
613	ERR SPED TAMPER STATUS FRONT	Inspect cable from main board assembly to the SPED module for damage. Make sure that the cable is connected at both ends. Verify that the DC operating voltages are correct. Restart ATM. Clear the error. If error persists, replace the SPED module.
614	ERR_SPED_TAMPER_STATUS_BACK	Inspect cable from main board assembly to the SPED module for damage. Make sure that the cable is connected at both ends. Verify that the DC operating voltages are correct. Restart ATM. Clear the error. If error persists, replace the SPED module.

615	ERR SPED TAMPER STATUS GRID	Inspect cable from main board assembly to the SPED module for damage. Make sure that the cable is connected at both ends. Verify that the DC operating voltages are correct. Restart ATM. Clear the error. If error persists, replace the SPED module.
616	ERR SPED TAMPER STATUS VOLTAGE	Inspect cable from main board assembly to the SPED module for damage. Make sure that the cable is connected at both ends. Verify that the DC operating voltages are correct. Restart ATM. Clear the error. If error persists, replace the SPED module.
617	ERR SPED SERIAL NUMBER CHANGE	Inspect cable from main board assembly to the SPED module for damage. Make sure that the cable is connected at both ends. Verify that the DC operating voltages are correct. Restart ATM. Clear the error. If error persists, replace the SPED module.
618	SPED serial number change	Inspect cable from main board assembly to the SPED module for damage. Make sure that the cable is connected at both ends. Verify that the DC operating voltages are correct. Restart ATM. Clear the error. If error persists, replace the SPED module.
619	NMD 100 shutter failed after reset	Inspect cable from Dispenser CMC assembly to the Shutter Assembly for damage. Make sure that the cable is connected at both ends. Verify that the DC operating voltages are correct. Restart ATM. Clear the error. If the Error persists consider replacing the cable between the Dispenser CMC Board and The Shutter Assembly, the Shutter Assembly PCB, the Shutter Assembly or the Dispenser CMC Assembly.
620	NMD 100 shutter OK after reset	To be determined

Modem Communication Status Codes		
Status Code	Description	
1	Time-out	<p>Possible Cause:</p> <ol style="list-style-type: none"> 1. Request has been sent. Time-out waiting for response or carrier was dropped. No characters were received. Time-out is typically 60 seconds. 2. Request has been sent. Time-out waiting for response or carrier was dropped. At least one character was received (ETX was never received). Time-out is typically 60 seconds. 3. EOT was received as first character after sending a NAK due to a bad response message. <p>Result: No money is dispensed, screen and receipt display system unavailable.</p>
3	BCD NO-ANSWER	<p>Possible Cause: Possible may be a processor or telephone hardware problem.</p> <p>Results: No money is dispensed, screen and receipt display system unavailable</p>
4	ERROR IN MODEM DATA	<p>Possible Cause: Unexpected data received from processor in response to message.</p> <p>Results: No money is dispensed, screen and receipt display system unavailable Can be a symptom of a bad modem or a modem not properly seated.</p>
5	Connect 1200 Baud then lost carrier or connection. Host hung up.	<p>Possible Cause:</p> <ol style="list-style-type: none"> 1. Telephone line is not dedicated. (ATM is being used with another devices connected to the line. 2. Telephone line is noisy and in general has poor quality characteristics. 3. Baud rate set to high for telephone line conditions. Change baud rate settings. 4. Modem may be defective. <p>Results: No money is dispensed, screen and receipt display system unavailable.</p>
6	BGD NO DIAL TONE	<p>Possible Cause:</p> <ol style="list-style-type: none"> 1. Used up all redial attempts and got No Dial Tone for each attempt. 2. Check local telephone line for proper operation. 3. Telephone hardware problems. <p>Results: No money is dispensed, screen and receipt display system unavailable.</p>
7	BGD – Busy	<p>Possible Cause:</p> <ol style="list-style-type: none"> 1. Dialed out, reached a busy signal 2. If problem persist, verify the phone number, try calling the number with a hand set to verify, work with the processor to rectify.
10	BGD – Logon	
11	No connect	<p>Possible Cause:</p> <ol style="list-style-type: none"> 1. Used up all redial attempt and got Busy Signal for each attempt or No Dial Tone for each attempt. 2. Got connected and never received ENQ within time-out period (14 Seconds). <p>Results: No money is dispensed, screen and receipt display system unavailable.</p>
13	BGD DONE GOOD	<p>Possible Cause: Communication was normal, but response header does not match request.</p> <p>Results: No money is dispensed, screen and receipt display system unavailable.</p>

14	BGD DONE BAD	<p>Possible Cause:</p> <ol style="list-style-type: none"> 1. EOT was received as first character after the first request message was sent. 2. If EOT is received on subsequent attempts, then Error Code 1 is reported <p>Results:</p> <p>No money is dispensed, screen and receipt display system unavailable.</p>
15	Timeout waiting for End of Transmission EOT	<p>Possible Cause:</p> <ol style="list-style-type: none"> 1. EOT from processor was not received within time out period. 2. Carrier was not lost, but no EOT was received before the time-out period expired. <p>Results:</p> <p>No money is dispensed, screen and receipt display system unavailable.</p>
16	Communication problem	
17	NO EOT	<p>Possible Cause:</p> <ol style="list-style-type: none"> 1. EOT from processor was not received within time out period. 2. Carrier was lost before receiving EOT. <p>Results:</p> <p>No money is dispensed, screen and receipt display system unavailable.</p>
18	OVERFLOW	<p>Possible Cause:</p> <p>Received more characters, than expected after request causing modem buffer overflow.</p> <p>Results:</p> <p>No money is dispensed, screen and receipt display system unavailable.</p>
48	NO ANSWER	<p>Possible Cause:</p> <ol style="list-style-type: none"> 1. Modem response was good, but operation was not performed. 2. This is normally an internal terminal problem. <p>Results:</p> <p>No money is dispensed, screen and receipt display system unavailable.</p>
65	Processor not communicating with the modem correctly	<p>Possible Cause:</p> <p>This is normally a terminal problem. The modem or the main board may cause the problem.</p> <p>Results:</p> <p>No money is dispensed, screen and receipt display system unavailable.</p>
100	Time-Out - Request has been sent, time-out waiting for response	<p>Possible Cause:</p> <ol style="list-style-type: none"> 1. Request has been sent. Time-out waiting for response or carrier was dropped. No characters were received. Time-out is typically 60 seconds. 2. Request has been sent. Time-out waiting for response or carrier was dropped. At least one character was received (ETX was never received). Time-out is typically 60 seconds. 3. EOT was received as first character after sending a NAK due to a bad response message. <p>Result:</p> <p>No money is dispensed, screen and receipt display system unavailable.</p>
101	No-Connect	<p>Possible Cause:</p> <ol style="list-style-type: none"> 1. Used up all redial attempt and got Busy Signal for each attempt or No Dial Tone for each attempt. 2. Got connected and never received ENQ within time-out period (14 Seconds). <p>Results:</p> <p>No money is dispensed, screen and receipt display system unavailable.</p>
103	No-Answer	<p>Possible Cause:</p> <p>Possible may be a processor or telephone hardware problem.</p> <p>Results:</p> <p>No money is dispensed, screen and receipt display system unavailable</p>

105	No EOT	<p>Possible Cause:</p> <ol style="list-style-type: none"> 1. EOT from processor was not received within time out period. 2. Carrier was lost before receiving EOT. <p>Results:</p> <p>No money is dispensed, screen and receipt display system unavailable.</p>
107	User Cancelled Transaction	<p>The Customer has terminated the transaction prior to the approval command being sent</p> <p>This is a notification, not an error.</p>
108	No response	<p>Request was sent but no response received after the specified time (60 seconds).</p> <p>See 100</p>
109	No ENQ	<p>Negotiation with host was complete, but no ENQ was received. (Dial-up protocol only).</p>
110	Invalid response	<p>Request was sent but invalid data was received while waiting for the beginning of a response (STX).</p>
112	Invalid LRC	<p>The LRC received in response was not valid.</p> <p>Possible Cause:</p> <p>There is an error with the Terminal ID or Comm Header.</p> <ol style="list-style-type: none"> 1. Verify the Terminal ID and Comm Header with the processor. 2. Bring up the section for entering the Terminal ID and Comm Header, hit clear, then re-enter the Terminal ID and Comm Header.
113	Response format error	<p>A response was received, the LRC was validated, but an error in the response format was found.</p> <p>Possible Cause:</p> <p>The processor is send data not correct for the modem ATM.</p> <ol style="list-style-type: none"> 1. Verify the terminal type with the processor. 2. Verify the terminal configuration with the processor.